

**GAS**  
AUDIO POWER

**MAX USER MANUAL**



# MAX PA1

PA1-3000.1DZ1 / PA1-3000.1DZ2

**HARDCORE CAR AUDIO**

## **WE PLAY LOUD!!**

We know what you want. You want it LOUD, and that's exactly what we do, what we live for. Vibrations, gut-punches and straight up loud music - that's what makes us tick. We won't dress up in fancy words or claim to be something we're not. We are the NO BULLSH!T car audio brand!









Every single product with the GAS logo on it is born out of passion, the same that has driven us for two generations and that will keep us rolling up to your neighbourhood, winning and pushing the limits for many generations to come!

It's up to you to choose your own level of loud, and if you don't like what we do that's OK. You are welcome back when you've had your first true GAS experience. We don't exclude, we don't judge and we do not make up any excuses for who we are.

**We are GAS and we are proud to be LOUD!**

# **GAS**

# TABLE OF CONTENT

	SAFETY.....	3
	UNPACKING.....	4
	DIMENSIONS.....	4
	SPECIFICATIONS.....	5
	MAX PA1-3000.1DZ1.....	5
	MAX PA1-3000.1DZ2.....	5
	Recommended cable sizes.....	6
	FUNCTIONS.....	7
	Input / Output / HPF / LPF.....	7
	Level (gain) / Bass EQ / Bass Remote / Power indicator.....	8
	Clip indicator / Protect indicator / Speaker output / Remote.....	9
	Power / Ground.....	10
	HOW TO.....	11
	Install amplifier.....	11
	Connect speakers.....	15
	Tweaking & settings.....	16
	TROUBLESHOOTING.....	22
	No power.....	22
	No sound.....	22
	Unwanted noise.....	22
	Distortion.....	22
	Protection.....	22
	WARRANTY & DISPOSAL.....	23
	THE GAS WORLD.....	24



# SAFETY

**NO COMPROMISES!** Especially when it comes to safety. Before installing your MAX PA1 series amplifier, make sure that you read through the manual thoroughly and follow the instructions. Save the manual for future usage and reference!

Make sure to pay attention to the instructions when you see this symbol: 

Make sure that your vehicle has a 12 VDC voltage negative ground system, that it can handle an increased power consumption, and that both the alternator and the power source are healthy and up to the task.

Don't install the amplifier inside the engine compartment or any other surface that may be compromised by water or dirt. Your amplifier will produce heat so make sure it'll have sufficient air circulation (4-5cm open space on all sides).

Keep the cables inside the vehicle separate from sharp edges or components that may be affected or take damage. Follow the recommended cable sizes and always use high quality cables and accessories. Even if you are eager to put the amplifier to use - take no shortcuts when installing the cables, make sure that all connectors are protected and secured, and take your time finding the perfect grounding point.

Don't drill any holes without checking what lies beneath, and don't cut anything without making sure that no important components risk being damaged.

There's a first time for everything, if you need help - ask a friend or contact your local GAS AUDIO POWER dealer/installer.

We want you to experience your products to the MAX, but we don't want you to injure yourself or others. Use common sense, respect high pressure levels and volume, and follow your local laws and regulations.

# UNPACKING

We know you're excited to dive head first into installing your new amplifier, but before you do: Make sure that the amplifier and all the accessories are included in the packaging.



Amplifier  
(1pc)



Manual  
(1pc)

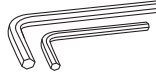

Allen keys  
(2pcs)



Screws  
(6pcs)



Sticker  
(1pc)



Remote cable  
(1pc)

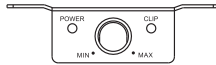

Remote  
(1pc)

# DIMENSIONS

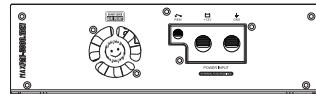
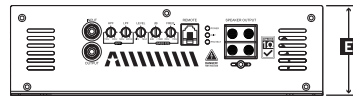
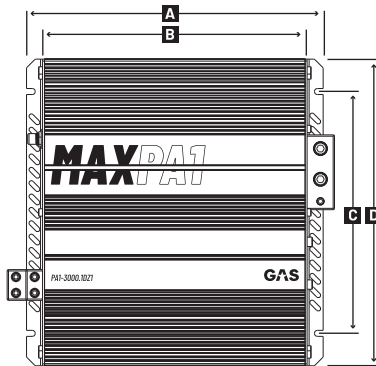

	A	B	C	D	E	
PA1-3000.1DZ1	243	195	181	229.5	66	mm
PA1-3000.1DZ2	243	195	181	229.5	66	mm

# SPECIFICATIONS

We take pride in our work! True, honest specifications and power ratings are an important part of all amplifiers. Listening, measuring and engineering are essential parts in our workshop. That's how we make sure to bring you an awesome product with NO BULLSH!T.

<b>MAX PA1-3000.1DZ1</b>	
Component	Pro Amplifier
Topology	Full range class D
Channels	Mono
Input mode	1 Ch
Power RMS (1 Ohm)*	1x3000W
Power RMS (2 Ohm)*	1x1700W
Power RMS (4 Ohm)*	1x900W
Frequency response	15-22000Hz
Low Pass Filter	50-22000Hz
High Pass Filter	15-80Hz
Crossover slope	12dB
S/N ratio (A-weighted)	>92dB
Bass EQ (level)	0-12dB
Bass EQ (frequency)	35-70Hz
Power/REM voltage	10-16V
Input sensitivity	0.2-10V
THD+N	<0.1%
Damping Factor	>120
Power Fuse	N/A
High level input	N/A
RCA line out	Yes (mono)
CLIP	Yes
Bass Remote	Yes/Level/Clip
Maximum current	250A

\*CEA-2006 Power Standard,  
14.4V >1% THD

<b>MAX PA1-3000.1DZ2</b>	
Component	Pro Amplifier
Topology	Full range class D
Channels	Mono
Input mode	1 Ch
Power RMS (1 Ohm)*	N/A
Power RMS (2 Ohm)*	1x3000W
Power RMS (4 Ohm)*	1x1700W
Frequency response	15-22000Hz
Low Pass Filter	50-22000Hz
High Pass Filter	15-80Hz
Crossover slope	12dB
S/N ratio (A-weighted)	>92dB
Bass EQ (level)	0-12dB
Bass EQ (frequency)	35-70Hz
Power/REM voltage	10-16V
Input sensitivity	0.2-10V
THD+N	<0.1%
Damping Factor	>120
Power Fuse	N/A
High level input	N/A
RCA line out	Yes (mono)
CLIP	Yes
Bass Remote	Yes/Level/Clip
Maximum current	250A

\*CEA-2006 Power Standard,  
14.4V >1% THD

# SPECIFICATIONS

## *RECOMMENDED CABLE SIZES*

<b>MAX PA1-3000.1DZ1</b>		
	<b>RECOMMENDED MINIMUM SIZE</b>	<b>MAX SIZE</b>
Power cable	0AWG (50mm <sup>2</sup> )	0AWG (50mm <sup>2</sup> )
Speaker cable	12AWG (4mm <sup>2</sup> )	8AWG (10mm <sup>2</sup> )
REM cable	18AWG (0.75mm <sup>2</sup> )	12AWG (4mm <sup>2</sup> )
<b>MAX PA1-3000.1DZ2</b>		
	<b>RECOMMENDED MINIMUM SIZE</b>	<b>MAX SIZE</b>
Power cable	0AWG (50mm <sup>2</sup> )	0AWG (50mm <sup>2</sup> )
Speaker cable	12AWG (4mm <sup>2</sup> )	8AWG (10mm <sup>2</sup> )
REM cable	18AWG (0.75mm <sup>2</sup> )	12AWG (4mm <sup>2</sup> )



# FUNCTIONS

NO COMPROMISES - that's the spirit of the MAX series. The MAX amplifiers are made for the enthusiasts out there who crave crazy amounts of power! We've packed these amplifiers with lots of cool features. We know you're itching to start building your new sound system, but make sure to read through these pages - so you can get the most out of your drivers!

## LOW LEVEL INPUT

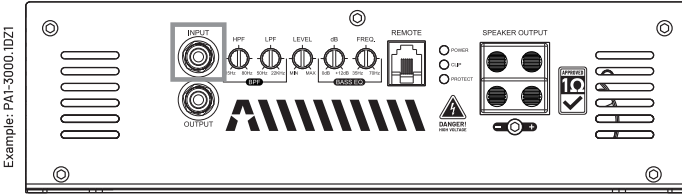

**INPUT (mono).**  
Connects to your head unit's RCA output.

## LOW LEVEL OUTPUT

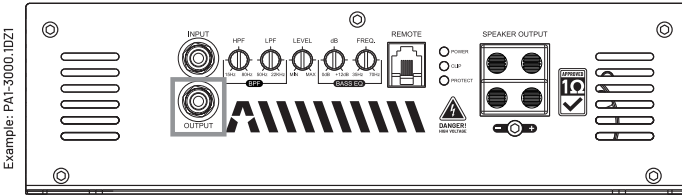

**OUTPUT (mono).**  
RCA output to send the original signal to two or more amplifiers.

## HIGH PASS FILTER

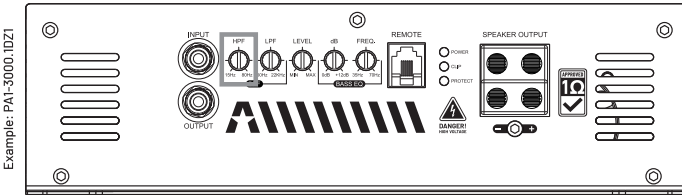

**HPF.** Limits the output below the selected frequency.



Follow the HOW TO instructions

## LOW PASS FILTER

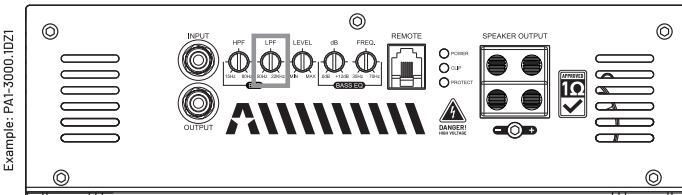

**LPF.** Limits the output above the selected frequency.



Follow the HOW TO instructions



# FUNCTIONS

## LEVEL (GAIN)

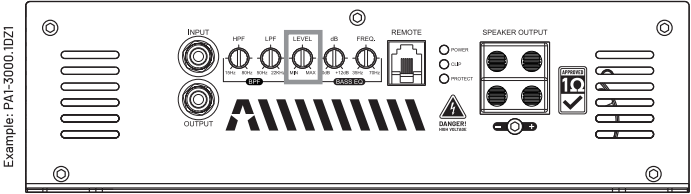

**LEVEL.** Sync your head unit's output signal with the amplifier.

 Follow the HOW TO instructions

## BASS EQ

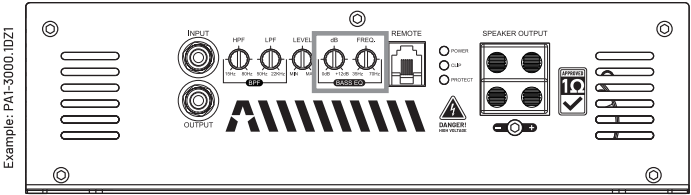

**BASS EQ.** Boost the bass with variables at 35-70Hz and 0-12dB.

 Follow the HOW TO instructions

## BASS REMOTE

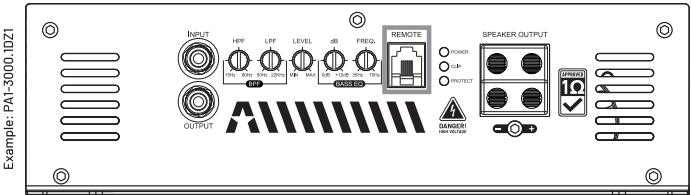

**REMOTE.** Use this to connect bass remote control knob for easy access and adjustment of the amplifier's output level. The bass remote includes PRT & CLIP indicators.

## POWER INDICATOR

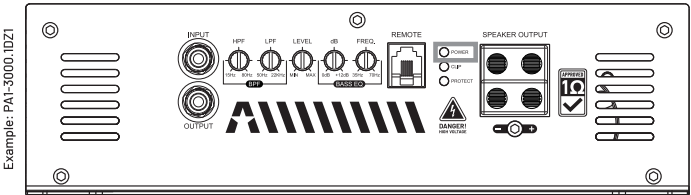

**POWER.** Illuminates when the amplifier is connected and on.

# FUNCTIONS

## CLIP INDICATOR

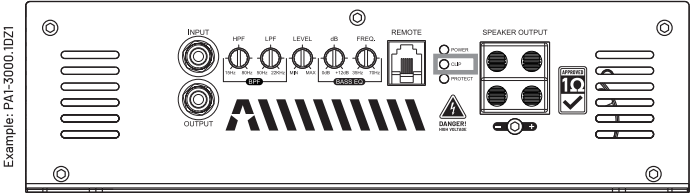

**CLIP.** When distortion exceeds 1%, the CLIP indicator glows yellow.

⚠ If it glows static, read HOW TO instructions.

## PROTECT INDICATOR

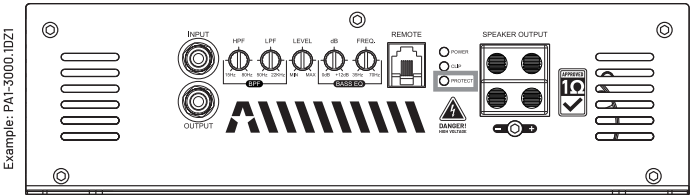

**PROTECT.** Illuminates when the amplifier indicates a failure.

⚠ If protect glows, read TROUBLE SHOOTING.

## SPEAKER OUTPUTS

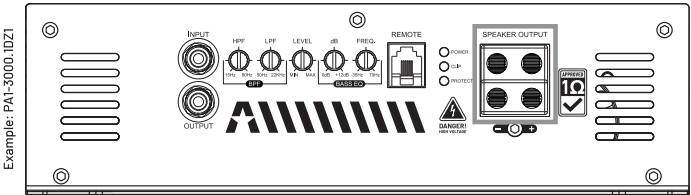

**SPEAKER OUTPUT.** Connect speaker(s) / subwoofer(s) to the amplifier.

⚠ Connect positive & negative output to matching connector on the subwoofer(s) / speaker(s).

## REMOTE

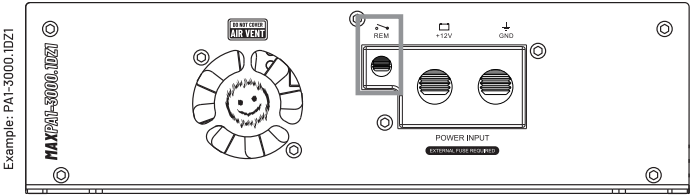

**REM.** Terminal input connector for the unit that controls the turn-on signal.

# FUNCTIONS

## POWER

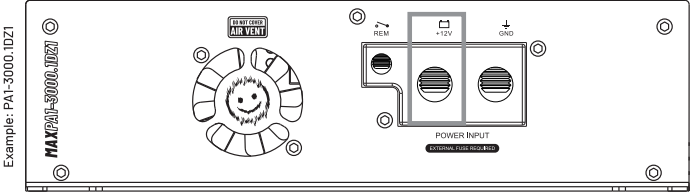

BATT +12V. Terminal input connection for +12V cable (+ power cable).

⚠ Make sure the vehicle use a 10-16V power source and electrical system.

## GROUND

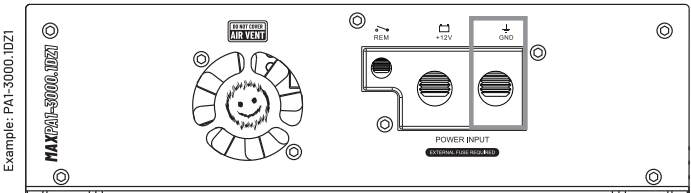

GND. Terminal input connector for ground cable (- power cable).

⚠ The GND cable must be in direct contact to the vehicle chassis or the power source's neg. (-) binding post.

# HOW TO

A well-built sound system will set you aside from the rest and elevate your vehicle! It's important that you carefully read the instructions on the following pages. This is to make sure that you install and use the amplifier correctly, for the true MAX EXPERIENCE!

## INSTALL AMPLIFIER



Make sure your vehicle is up to task. You need a 12VDC negative ground electric system and the power source and the alternator should be fully functional and healthy.



Better safe than sorry! Find a location that has a normal temperature and is safe from rain, excessive moisture and dirt when you're going to install your amplifier.

*Disconnect and secure the negative terminal from your power source* to eliminate the risk of damaging yourself or the products. Place the negative terminal in a secure position so that it won't accidentally contact the positive or the negative power source post.

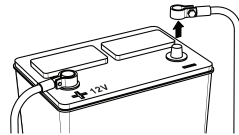

*Have all the necessary tools ready and close at hand.* Make sure that the needed wiring accessories are prepared. Your wiring kit should be of the recommended size depending on the specific amplifier (see the SPECIFICATION chapter).

	0-1m	1-2m	2-3m	3-4m	4-5m	5-6m	6-7m	7-8m
300-500 AMP								
225-300 AMP								
150-225 AMP								
125-150 AMP								
105-125 AMP								
85-105 AMP								
65-85 AMP								
50-65 AMP								
35-50 AMP								
20-35 AMP								

**Cable size:**

- A.W.G: 8 Gauge  
MM<sup>2</sup>: 10mm<sup>2</sup>
- A.W.G: 4 Gauge  
MM<sup>2</sup>: 20mm<sup>2</sup>
- A.W.G: 2 Gauge  
MM<sup>2</sup>: 35mm<sup>2</sup>
- A.W.G: 0 Gauge  
MM<sup>2</sup>: 50mm<sup>2</sup>
- A.W.G: 2x 0 Gauge  
MM<sup>2</sup>: 2x 50mm<sup>2</sup>



# HOW TO

*It's time to find the perfect location to place your amplifier!* Since the amplifier produces heat you don't want to install it where it might get overheated. Find a place where air can circulate around it to stay cool. Also leave enough space so it's easy to connect your cables and reach for the controls. Don't bolt the amplifier to your vehicle chassis (if this is your only option, you need to isolate the amplifier from the screws).

*Find the best way to run the cables through your vehicle!* This might take some time, and may vary between different models. Preferably the cables shouldn't be visible when you're finished and they shouldn't be placed in a way that they obstruct any of the vehicle's functions or hinder you from operating the vehicle safely. It's also important you don't run the power cable together with the signal cable, since this can cause interference.

**Grounding is ESSENTIAL!** The ground cable must be in direct connection with the vehicle's metal frame. So take your time finding the perfect bolt or area for this. There should be no paint or dirt preventing a clean connection, so scrape down the area where the ring terminal touches/is in contact with the frame.

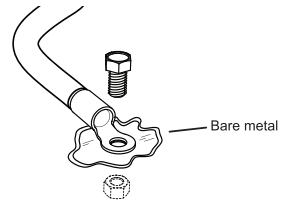

**Connect the power cable to the positive power source terminal,** preferably together with the vehicle +12V cable. A fuse holder needs to be placed on the cable at a 15-25 cm distance from the terminal and before any steel parts. **WARNING!** Install the fuses as the absolute final step when the rest of the installation is complete.

The next step is to **run a remote wire from your head unit to the amplifier,** preferably together with the power cable (see illustration below). Use a separate 14-18 AWG wire for the remote signal. You also need a **high quality RCA signal cable.** To make sure there's no interference, the RCA cable should be run as far away from the power cables as possible, preferably on the opposite side of the vehicle (see illustration below).

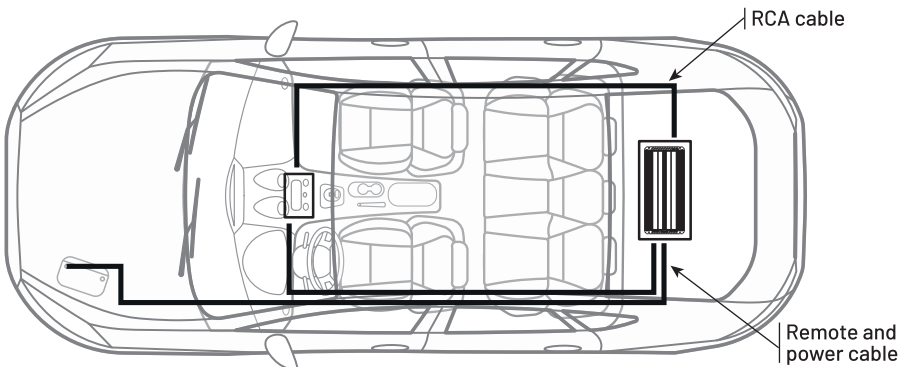

# HOW TO

Use the right speaker cable for the job! Make sure to use the recommended size, and follow the polarity of the speaker wire from the speaker to the amplifier.

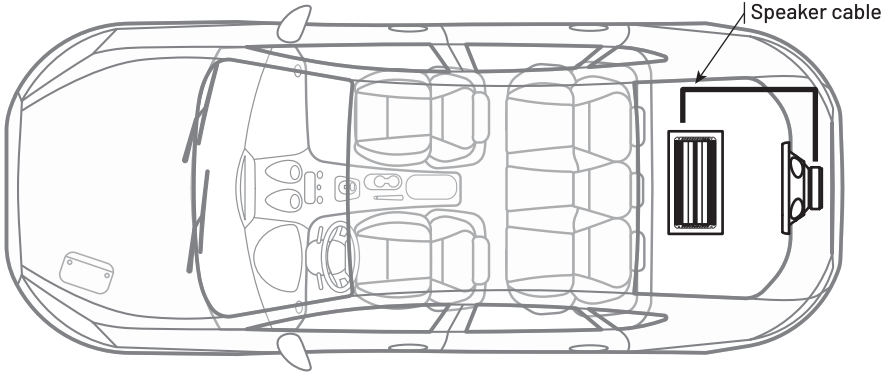

See the SPECIFICATION chapter for recommended cable sizes, or use this table to find your minimum recommended size for speaker cables:

	0-1m	1-2m	2-3m	3-4m	4-5m	5-6m	6-7m	7-8m
5000 W								
4000 W								
3000 W								
2500 W								
2000 W								
1500 W								
1200 W								
900 W								
600 W								
450 W								
300 W								
150 W								
100 W								
50 W								

**Cable size:** A.W.G: 16 Gauge MM<sup>2</sup>: 1,5mm<sup>2</sup> A.W.G: 14 Gauge MM<sup>2</sup>: 2,5mm<sup>2</sup> A.W.G: 12 Gauge MM<sup>2</sup>: 4mm<sup>2</sup> A.W.G: 10 Gauge MM<sup>2</sup>: 6mm<sup>2</sup> A.W.G: 8 Gauge MM<sup>2</sup>: 10mm<sup>2</sup>



# HOW TO

*We're almost there! Are you ready?* When all cables have been installed and secured with cable ties and wire looms, you're ready to start up your system.



Follow the instructions on your amplifier and/or in the manual to make sure that each cable is connected to the correct output and input. **WARNING!** Make sure that any Bass EQ function is set to a minimum, that the level/gain is set to a minimum and all crossovers are turned off/set to default.

1)

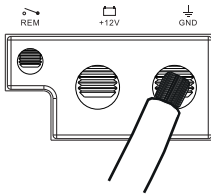

2)

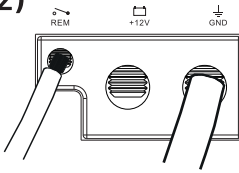

3)

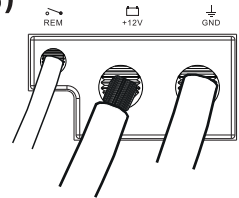

**Install the fuses in the fuse holder and reconnect the negative power source terminal.** Be prepared to disarm your vehicle's alarm and to enter your radio/source unit code.

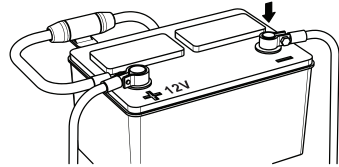

**Time to test it out!** Turn the ignition on your vehicle and turn the source/head unit on. Make sure that the amplifier's power indicator is on and shows that there's power coming all the way through, if not – turn the head unit off, the ignition off, disconnect the negative power source terminal and re-check all your connections.

**One last thing...** We know you are ready to show off your upgraded sound system to the world, but before you reattach all panels and put the head unit back in place, do a final check. Make sure that all the speakers have a signal by playing some really good music, turning the head unit volume up just a bit, and just slightly turning the level/gain on the amplifier. **WARNING!** Do not turn the level/gain more than to just hear the music (read through the HOW TO-section on setting the level/gain before further use).

# HOW TO

## CONNECT SPEAKERS

Make sure you got everything you need when connecting your subwoofers/speakers to your sound system's new powerhouse. Go for the classical setup and connect a great subwoofer to your amplifier, or go the extra mile with TWICE the bass and performance of your sound system by connecting two subwoofers to your amplifier!



Make sure to have the correct load on your amplifier, going below specified impedance will damage your amplifier. Usually you can find the speaker's impedance in their manual.

### DUAL TERMINAL MONO AMPLIFIER

(NOTE: Both the negative and positive speaker output terminals are internally connected in parallel, so either wiring setup can be used.)

Single woofer/speaker (total impedance minimum 1 or 2 Ohm based on model):

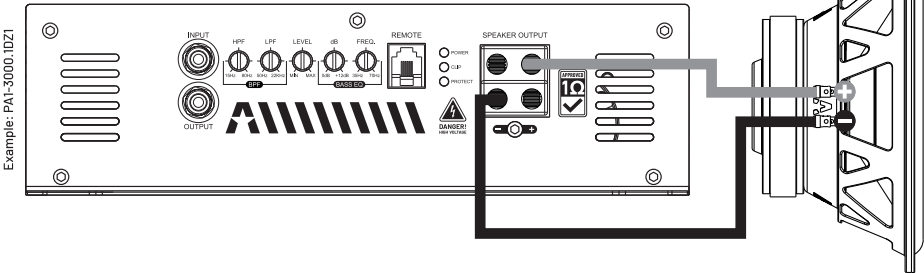

Dual woofers/speakers (total impedance minimum 1 or 2 Ohm based on model):

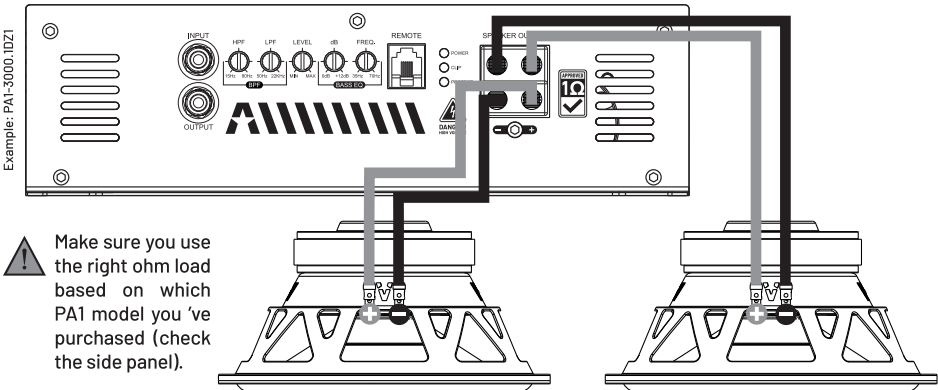

Make sure you use the right ohm load based on which PA1 model you've purchased (check the side panel).



# HOW TO

## TWEAKING & SETTINGS

The devil is in the details. Tweak the settings on your MAX amplifier using the following recommendations and cross the line that separates the average user from the hardcore high-power audio junkie!

### LEVEL (GAIN)

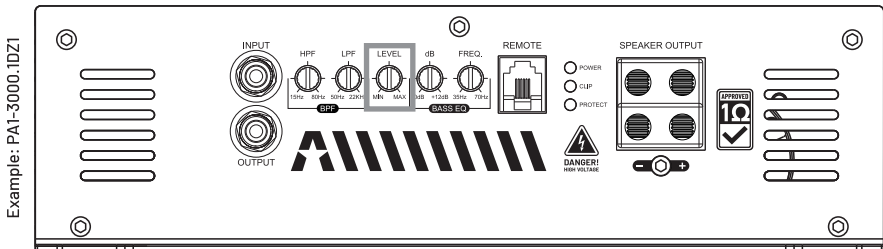

**Remember that the level/gain setting is not a volume control!** It's there to let you sync your head unit's output signal with the amplifier.

Every sound system is different, and there are several ways to set the amplifier level/gain. To get started you can use your own senses and audio skills by following the instructions below. On the following page we also tell you how to set the level/gain with an oscilloscope.

#### Use your own senses and audio skills

If you are planning to set the level/gain by hand, do so in a quiet environment. The more experience you have in making this sort of settings, the easier it is to get a good result. If you haven't done this before, a tip is to ask a friend to help you out.

- Set the level/gain to minimum.
- Make sure that your Bass EQ and other EQs are set to Zero/minimum
- Set the volume on your head unit to 75%.
- Start to play your favourite track that you are really familiar with and knows the sound of by heart, or use the test tones on a sine-wave test CD or digital test track.
- Slowly start to increase the level/gain.
- When you see the yellow LED indicator turn on and start flickering you will hear that the sound starts to change and you can note distortion. Stop the level/gain adjustment and turn the level/gain down slightly until the clip LED turns off.
- You have now set the level/gain on your amplifier correctly.

# HOW TO

## Use an oscilloscope for high precision result

When you are setting the level/gain on your amplifier with an oscilloscope you are measuring the output power of the amplifier. **WARNING!** Make sure that the positive speaker cable is removed from the amplifier.

Set the level/gain to minimum. Start a CD/digital sine-wave test track with your head unit's volume level at 75% and set the oscilloscope to AC Volts.

Connect the test probes on the amplifier's speaker terminals. When you're connected, you will see soundwaves on the oscilloscope. The soundwaves should be moving in a steady pattern with smooth tops and bottoms.

While observing the oscilloscope, start to slowly increase the level/gain until you start to see irregularities in the soundwaves. When the waveform is starting to look squared, turn down the level/gain until the waveform is back to smooth curves (see the graphics below).

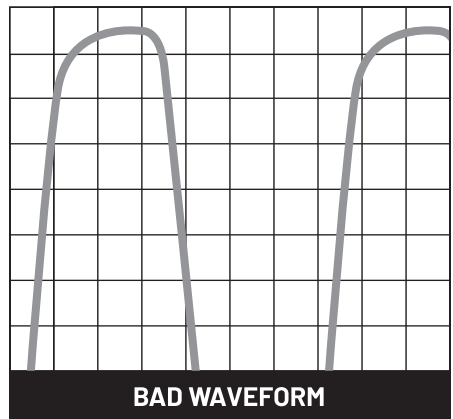
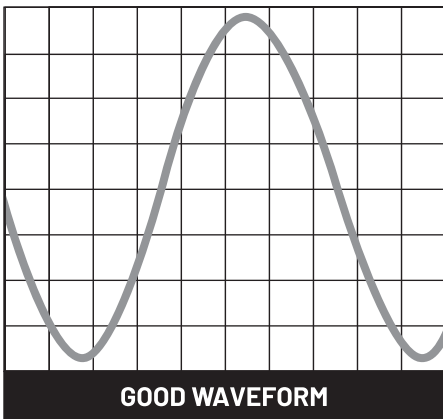

Remember - if you use your BASS EQ or any other sort of amplitude enhancement functions after setting the level/gain, you will have to do it all over again!

# HOW TO

## BASS REMOTE

With the MAX PA1-3000.1DZ1 / PA1-3000.1DZ2 amplifier, we have included an awesome bass remote. The included bass remote control makes it possible for you to fine tune the level of bass from the front seat while listening to your favorite song.

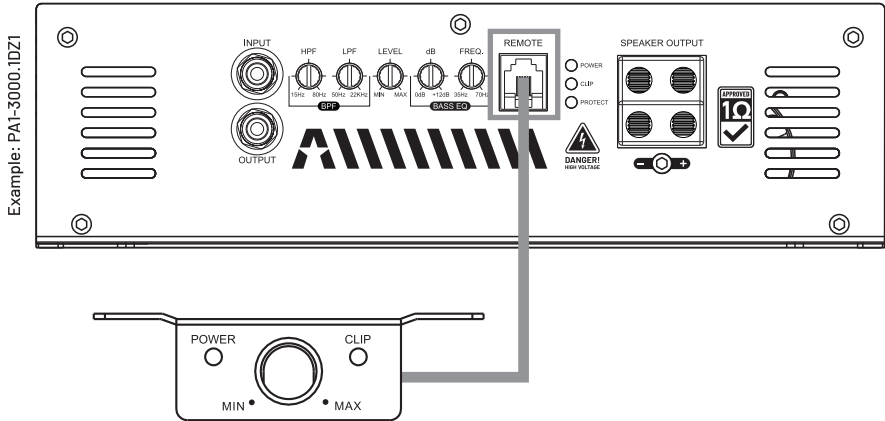

The max level will be determined by how the level/gain knob was set on the amplifier in the previous stage. It's therefore very important to set level/gain control at the correct level without the LED clip glowing yellow or start flickering. You can also turn it all the way down to minimum if you want to reduce the level of bass output to minimum.

When you are setting the level/gain on your amplifier, make sure that the bass remote knob is positioned on MAX. This bass remote can't increase the level above the maximum level/gain setting on the amplifier. It's a useful tool to lower the gain and/or turn it back up to fine tune your listening experience.

 Always make sure that your full concentration is on the road while you drive. Do not make detailed adjustments on the bass remote's setting while driving.

# HOW TO

## CROSSOVER

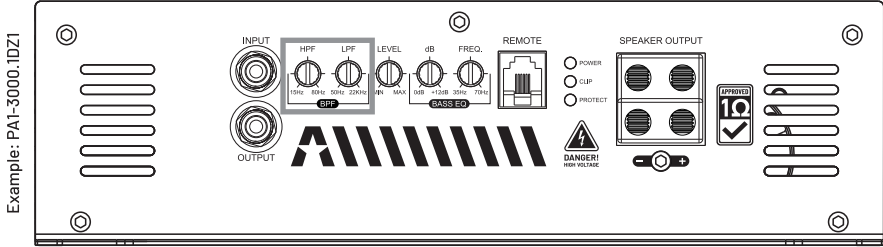

The crossovers are used to regulate the maximum and minimum frequencies each speaker is allowed to reproduce. The first thing you need to do is to find out the frequency response of each subwoofer/speaker you wish to connect to the amplifier. Don't allow the filters to pass through lower- or higher frequencies than your subwoofers/speakers can handle.

The different frequency bands reproduce different types of sound:

HZ	20-40	40-80	80-160	160-320	320-640	640-1280	1280-2560	2560-5120	5120-10200	10200-20400
Band Type	Low bass	Mid bass	Upper bass	Lower midrange	Middle midrange	Upper midrange	Lower treble	Middle treble	Upper treble	Top octave

**High-Pass Filter (HPF):** 15Hz-80Hz variable, no frequencies below the chosen frequency cut point are allowed to pass through to a speaker/subwoofer.

**Low-Pass Filter (LPF):** 50Hz- 22000Hz variable, no frequencies above the chosen frequency cut point are allowed to pass through to a speaker/subwoofer.

**Band-Pass Filter (BPF):** 15Hz- 22000Hz variable, by combining HFP and LFP a Band-pass filter is created. Only frequencies between the chosen frequencies will pass through.

**Hint!** MAX PA1-3000.1DZ1/PA1-3000.1DZ2 has HPF/LPF crossovers with 12dB octave slope, so if you for an example turn the HPF dial to 80 Hz the sound will be 12db lower at 40Hz. The same if you turn the LPF dial to 80Hz the level will be 12db lower at 160Hz and so on.

The MAX PA1 amplifiers are designed to offer you the option to either connect them to a subwoofer or to full range speakers/midrange drivers. The built-in crossovers need to be set correctly depending on what type of setup you are going to apply. On the following page we show the most common settings to use on your amplifier.

If you want more help/guidance in how to use the filter settings, consult your local GAS CAR AUDIO dealer.

# HOW TO

## SUBWOOFER:

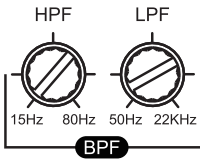

Set the HPF dial to 15Hz and the LPF dial to 80Hz, this gives you a good starting point for tweaking and finding the desired crossover points.

(The HPF can be used as a Subsonic filter. If you set the frequency dial at 30Hz, frequencies below will be attenuated by 12db per octave. That means that the level of the subwoofer will be 12dB lower at 30Hz compared to 60Hz)

## MIDWOOFER/MIDRANGE DRIVER:

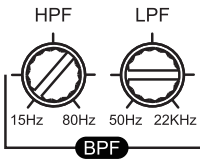

Set the HPF dial to 15Hz and the LPF dial to 4KHz. This way your connected midwoofer/ midrange will play from 15Hz to 4KHZ. Depending on the specification of the connected speaker you need to adjust both HPF and LPF to match your speakers performance (Band- Pass Filter).

## COAXIAL SPEAKER / SPEAKER WITH PASSIVE CROSSOVER:

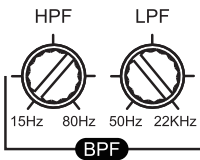

Set the HPF dial to 15Hz and the LPF dial to 22KHz. Turn the HPF dial up so you can hear that the speaker doesn't play the lowest notes. Adjust the dial down to where you can hear good music/bass coming from your speakers without hearing distortion. Usually a high pass crossover frequency between 40-80Hz sounds the best, but it depends on factors such as speaker size, location and if a subwoofer's connected.

# HOW TO

## BASS EQ

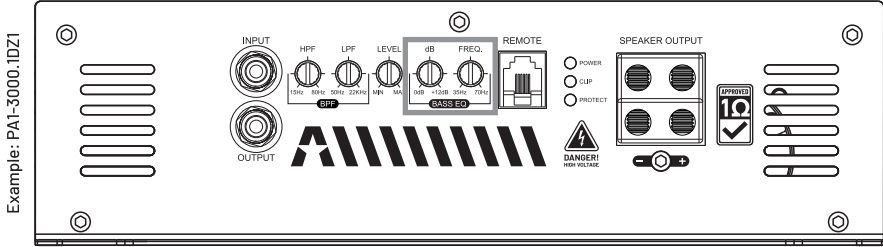

If everything is tuned correctly and the level/gain has been set, the BASS EQ should remain in default (0dB). This function will apply level/gain between 35Hz-70Hz. Be advised that equing the bass from 0-12 dB is a lot, an increase of +3dB doubles the output! If used incorrectly, this can permanently damage your speakers/subwoofers.

**WARNING!** The information below is for experienced users and bass addicts only, if you are new to the wonderful world of low frequencies, leave the BASS EQ in default setting or consult with your local GAS AUDIO POWER dealer.

If you use the BASS EQ, make sure to turn down your level/gain first (to 0db) before you start adjusting it. Start a music track and very carefully turn the dB dial up until you start hearing distortion, then follow the HOW TO chapter about level/gain to optimize your system.



Incorrect usage of the BASS EQ can permanently damage your speakers/subwoofers.

# TROUBLESHOOTING

## NO POWER

Use a multimeter to measure the voltage on the +12V terminal and the remote signal terminal. Use a multimeter to make sure that you have a negative ground connection. Check the built-in fuse (if there's one) on the amplifier. If there's no power coming through – Control the power cable's fuse, if it is intact – make a full check of the wiring to ensure cable integrity. When all of the above has been tested/looked over, and all is as it should be but there's still no power coming through to the amplifier, consult your local GAS AUDIO POWER dealer.

## NO SOUND

Check your head unit to make sure no settings are limiting the amplifier functions. Check all signal cables. Check all speaker cables. Check all speakers. When all of the above has been tested/looked over, and all is as it should be but there's still no sound, consult your local GAS AUDIO POWER dealer.

## UNWANTED NOISE

Check your negative grounding point and make sure that the surface is clean (consult the HOW TO instructions). Make sure that your signal cables or speaker cables are not too close to the power cables. Look over your wiring so there's no damage or connection issue.

## DISTORTION

Check the speaker cables to make sure that the polarity isn't reversed on one channel. Check the settings on the amplifier, make sure that the level/gain is set according to the instructions. Lower/turn off bass EQ function on the amplifier if used. Check subwoofers.

## PROTECTION

Check all speakers and make sure that no leads or voice coils are damaged. Make sure all connections are made as they should be and that no leads touch the amplifier chassis.

The amplifier will go into protection if it's overheated. As soon as the normal operating temperature is back it will automatically turn back on. To prevent the amplifier from overheating, make sure to follow the HOW TO installation instructions and leave enough space around the amplifier so that the airflow is optimized.

The protection mode is activated if the impedance load's lower than the amplifier limitations. If the input voltage is lower or higher than the amplifier limited range the amplifier will go into protection. When all of the above has been tested/looked over, and all is as it should be but the amplifier is still in protection mode, consult your local GAS AUDIO POWER dealer.

# WARRANTY & DISPOSAL

Our products are made with passion and expertise to give you the products you need to have an awesome audio powered experience that's LOUD. All our products are covered by warranty, depending on the conditions in the country where it's sold. The warranty is valid from the date of the original receipt as proof of purchase (warranty period differs depending on local warranty laws and policies).

If the amplifier is returned for service, please include the original dated receipt (or a copy) with the product. Make sure that the amplifier is packaged properly and secured, preferably in its original packaging. If you have any questions regarding the terms of warranty, please contact your local GAS AUDIO POWER dealer/distributor.



The crossed-out wheeled bin symbol means that the product, literature and packaging included must be taken to separate collection at the end of their working life. Don't dispose of these products as unsorted municipal waste: take them for recycling. For info on your nearest recycling point, check with your local waste authority.



This product has been granted with the CE certification mark to show that the product follows the health, safety, and environmental protection standards for products sold within the European Economic Area (EEA).



GAS AUDIO POWER products comply with the relevant provisions of the RoHS Directive for the European Union. In common with all Electrical and Electronic Equipment (EEE) the product shouldn't be disposed of as household waste. Alternative arrangements may apply in other jurisdictions.



GAS AUDIO POWER is a global partner of the European Mobile Media Association, an organization that focus on promoting the custom made mobile media installations to consumers.



# THE GAS WORLD

You've entered the world of GAS. We aim to please, and we've made sure to have products made for you. No matter what stage of the LOUD-addiction you might find yourself in, there is a GAS product to fill your need.

## ***MAD***

Just starting out? The MAD series is made to play LOUD and to be the express lane to a no bullsh!t sound system that will make sure everyone can hear you coming!

## ***MAX***

The MAX series holds products made to deserve the center stage. Powerful, heavy duty and designed to be noticed. We made NO COMPROMISES because we know that you wouldn't accept it.

## ***CMP***

The CMP series has been developed for the crucial seconds when the dB-counter starts to tick. All CMP products have hand-picked, high quality, COMPETITION GRADE components and they are specially designed to withstand an awesome amount of power.



# THANKS FOR JOINING GAS AUDIO POWER!



**GAS**  
**AUDIO POWER**

GAS AUDIO POWER and SHAKY are registered trademarks by Winn Scandinavia AB and is protected by relevant laws and jurisdictions such as Copyright and Trademark laws.

Winn Scandinavia AB | Elementvägen 15, 70227 Örebro, Sweden | [www.winnscandinavia.com](http://www.winnscandinavia.com)

Winn Scandinavia AB reserves for possible typos, factual or numeric errors that may have been printed on any products, package designs, user manuals and/or other included accessories.



**GAS**

**GAS**  
AUDIO POWER