



# MAX

M150-BDX

**HARDCORE CAR AUDIO**

## **WE PLAY LOUD!!**

We know what you want. You want it LOUD, and that's exactly what we do, what we live for. Vibrations, gut-punches and straight up loud music - that's what makes us tick. We won't dress up in fancy words or claim to be something we're not. We are the NO BULLSH!T car audio brand!











Every single product with the GAS logo on it is born out of passion, the same that has driven us for two generations and that will keep us rolling up to your neighbourhood, winning and pushing the limits for many generations to come!

It's up to you to choose your own level of loud, and if you don't like what we do that's OK. You are welcome back when you've had your first true GAS experience. We don't exclude, we don't judge and we do not make up any excuses for who we are.

**We are GAS and we are proud to be LOUD!**

# **GAS**

# TABLE OF CONTENT

 SAFETY.....	3
 UNPACKING.....	4
 DIMENSIONS.....	4
 SPECIFICATIONS.....	5
 FUNCTIONS.....	8
Head unit.....	8
Remote control.....	10
 HOW TO.....	11
Quick start.....	11
Easy audio.....	14
EQ settings.....	15
Audio control.....	16
Understanding x-over.....	17
X-over.....	19
Understanding delay settings.....	22
Delay settings.....	23
FM Tuner.....	25
Bluetooth.....	26
System.....	28
 PERSONAL NOTES.....	30
 TROUBLESHOOTING.....	31
No power.....	31
Unwanted noise.....	31
Distortion.....	31
 WARRANTY & DISPOSAL.....	32
 THE GAS WORLD.....	33



# SAFETY

**NO COMPROMISES!** Especially when it comes to safety. Before installing your MAX head unit, make sure that you read through the manual thoroughly and follow the instructions. Save the manual for future usage and reference!

Make sure to pay attention to the instructions when you see this symbol: 

Make sure that your vehicle has a 12 VDC voltage negative ground system, that it can handle an increased power consumption, and that both the alternator and the power source are healthy and up to the task.

Do not install the head unit where it may be exposed to dirt, excessive damp or moisture. If the head unit is exposed it might result in electric failure, shock or damage to the product. Your head unit will produce heat so make sure it'll have sufficient air circulation. Servicing is required when the product has been damaged in any way and /or doesn't operate normally. Refer all servicing to qualified service personnel only.

Keep the cables inside the vehicle separate from sharp edges or components that may be affected or take damage. Follow the recommended cable sizes and always use high quality cables and accessories. Even if you're eager to put the head unit to use - take no shortcuts when installing the unit, make sure that all connectors are protected and secured.

Don't drill any holes without checking what lies beneath, and don't cut anything without making sure that no important components risk being damaged.

There's a first time for everything, if you need help - ask a friend or contact your local GAS AUDIO POWER dealer/installer.

We want you to experience your products to the MAX, but we don't want you to injure yourself or others. Use common sense, respect high pressure levels and volume, and follow your local laws and regulations.



# UNPACKING

We know you're excited to dive head first into installing your new head unit, but before you do: Make sure that the head unit and all the accessories are included in the packaging.

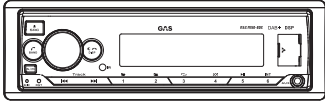

Head unit



Remote

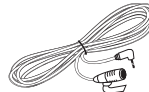

Microphone

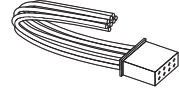

ISO connection  
(2 pcs)



Manual

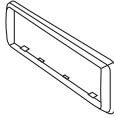

Trim panel

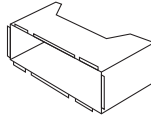

Mounting  
sleeve



Removal keys  
(2 pcs)



DAB antenna

# DIMENSIONS

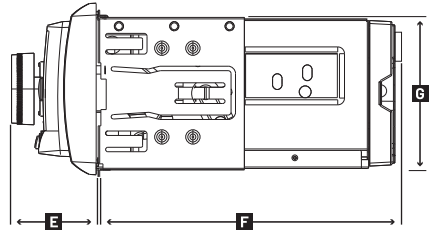
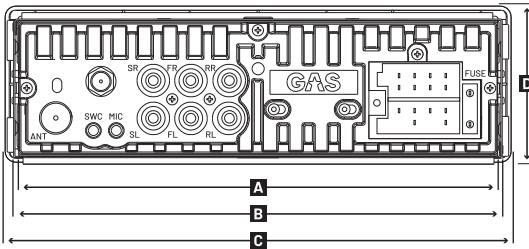

	A	B	C	D	E	F	G	
M150-BDX	178	182	188	58	32	111	53	mm

# SPECIFICATIONS

We take pride in our work! Listening, measuring and engineering are essential parts in our workshop. That's how we make sure to bring you an awesome product with NO BULLSH!T.

## GENERAL

Power source	14.4V (11-16V)
Grounding	Negative type
Maximum current consumption	15A
Operational temp.	-10°C to +60°C
Weight (net)	0.6KG
LED backlighting	7 colors
Illuminated buttons	7 colors
True 4V pre-outs 3 pair	Front, Rear, Sub
Steering wheel remote	Compatible
Remote control	Included
Power antenna lead	+12V to external amp. or electric antenna
24-bit DAC	Yes
Firmware updates	Via USB-port
Dimmer settings	Yes
Clock	Yes
Memory backup	Yes
App control	Yes

## AUDIO

MAX output power	4x50W
Full bandwidth power (at less than 1%THD)	4x25W
Speaker impedance	4- 8 Ohm
Pre-out level	4000mV / 10kOhm load
Frequency response	15Hz-20kHz (± 1dB)
Pre-out impedance	> 100 Ohm

## USB / MicroSD

USB standard	USB1.1, USB 2.0
File system	FAT12/16/32
Maximum supply current	DC 5V=1.5A
Frequency response	15Hz-20kHz (± 1dB)
Total harmonic distortion	0.01% (1kHz)
Signal to Noise ratio	104dB (1kHz)
Channel separation	92dB (1kHz)
MP3 decode	Compliant with MPEG1/2 Audio Layer3

# SPECIFICATIONS

## FM RADIO

Frequency range	87.5MHz-108MHz (50kHz step)
Usable sensitivity	7dB (S/N=30dB)
Quieting sensitivity	55dB (S/N=46dB)
S/N ratio (mono)	MNO 1MV 64dB
Frequency response	30Hz - 15kHz (± 3dB)
Stereo separation	40dB (1kHz)

## DAB+ RADIO

Frequency range	175MHz-239MHz (Band III)
Sensitivity	97dBm
S/N ratio	90dB
Frequency response	20Hz - 20kHz (± 3dB)
Antenna Connector	SMB type
Antenna Output (Volt)	12V DC
Antenna MAX Current	<100mA

## AUX

Frequency response	20Hz - 20kHz (± 3dB)
Input MAX voltage	1000mV
Input impedance	30kOhm

## BLUETOOTH

Version	BT 5.0
Bluetooth frequency range	2402GHz- 2480GHz
RF output power (E.I.R.P.)	4dBm (MAX), Power Class2
Maximum communi- cation range	Line of sight, approx 10m
Profile	HFP1.7.1(Hands Free Profile)
	A2DP
	AVRCP1.6.1
	Serial Port Profile

# SPECIFICATIONS

<b>DSP</b>	
Model	GAS DEXT7375 DSP IC
Processor speed	160Mhz floating point
Equalizer 20-band	50Hz, 63Hz, 80Hz, 100Hz, 125Hz, 200Hz, 250Hz, 315Hz, 400Hz, 500Hz, 630Hz, 800Hz, 1.25kHz, 2kHz, 3.15kHz, 5kHz, 6.3kHz, 10kHz, 12.5kHz, 16kHz
Flexible Q-value	2,3,4
Equalizer range	-9dB to +9dB (1dB steps)
Time alignment	0-610cm (1cm steps) (all channels)
X-over 2-ways	Front HPF, Rear HPF, SubW LPF
X-over 3-ways	Tweeter, Midrange HPF, Midrange LPF, SubW LPF
SLOPE	6,12,18,24 dB/Oct
GAIN	-8 to 0 (1dB steps)
High shelf filter (tweeter attenuation)	1, 1.6, 2.5, 4, 5, 6.3, 8, 10, 12.5, 16 KHz



# FUNCTIONS

NO COMPROMISES - that's the spirit of the MAX series. The MAX head units are made for the enthusiasts out there who crave high precision audio! We've packed the head unit with a bunch of interesting features. We know you're itching to get your new sound system going, but make sure to read through these pages - so you can get the most out of your setup!

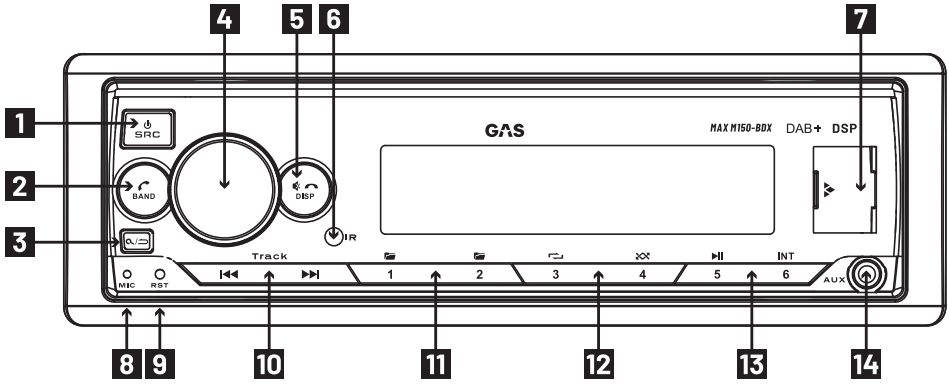

**1 SRC ON/OFF**

Short press: Switch on device  
 In operation: Change of source  
 FM Radio, DAB Radio, USB (when connected), Aux in, Bluetooth.

Long press: Switch off device.

**2 BAND / PHONE**

*Radio mode:* Changes to next 6 stored stations.

*BT mode:* Calling the last dialed number on your mobile phone. Answer incoming Call.

*USB mode:* Name of the File, Folder, Title, Album, Artist.

**3 SEARCH / BACK**

*Radio mode*  
 Short press: Station 1  
 Long press: Search station

*MENU mode:* Back. Return to the previous menu

*USB mode:* Jumps to the selected number. Turn Volume knob to find what number on the file, confirm by pushing the knob.

**4 VOLUME KNOB**

Rotate to adjust volume. Navigate up/down in the menus

MENU mode: Press to select.

# FUNCTIONS

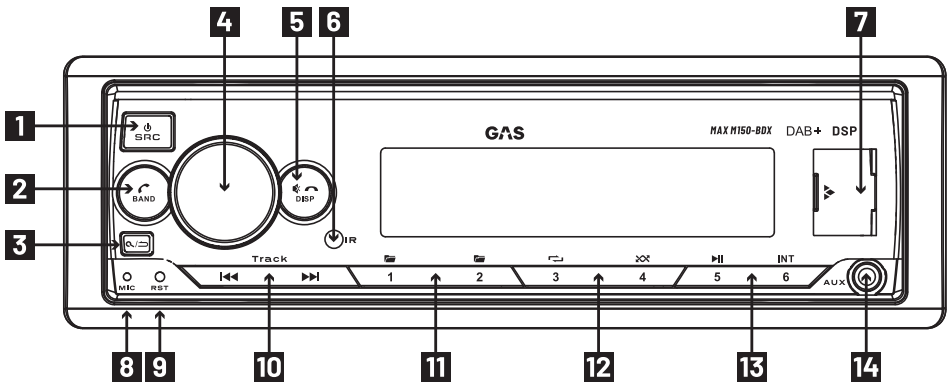

## 5 MUTE / DISP

Short press: Mute the sound.  
Long press: Turn off the display.

## 6 INFRARED RECEIVER

Infrared eye for remote control.

## 7 MicroSD & USB PORT

Playback from MicroSD / USB devices and USB charging (5V 1.5A)

## 8 BUILT-IN MICROPHONE

Mic. for answering phone calls.

## 9 RESET BUTTON

Restore to default factory settings of the device. **WARNING!** All your personal settings will be lost.

## 10 TRACK

*Radio mode:* Start/Stop search radio station.

*BT mode:*

>>| One press: Skip to next track

|<< One short press: Jump to the beginning of the track (if the track has played +10 sec, or prev. track).

|<< Press twice: Go to prev. track.

## 11 NUMBER BUTTONS (1-6)

12  
13 *Radio mode:* Stored radio stations.

*USB mode:*

1 Go to previous folder

2 Go to next folder

3 Repeat - Track / Folder / OFF

4 Random Play - ALL / OFF

5 Paus/Play

6 Int - SCAN ON / SCAN OFF

## 14 AUX PORT

3.5mm external audio input

# FUNCTIONS

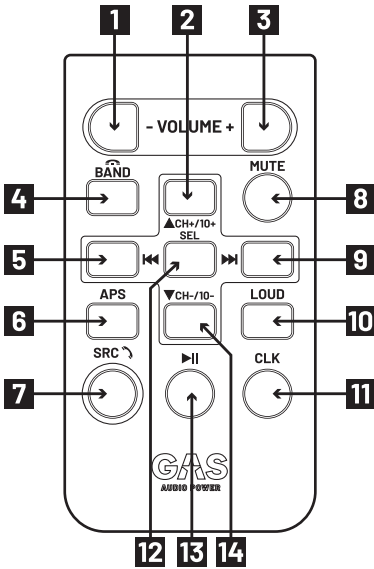

**1** **VOLUME - / VOLUME +**  
**3** Lower / Increase the volume.  
*In menu:* Down / Up scrolling.

**2** **CH+ / 10+ / CH-/10-**  
**14** Change radio channel + / -

**4** **BAND**  
 Browse stored radio channel.  
*In phone call:* Hang up

**5** **PREVIOUS / NEXT TRACK**  
**9** Go to previous / next track.

**6** **APS**  
*In menu:* Go back.  
*Radio mode:* Automatic scan and save channel preset.

**7** **SRC**  
 Switch between sources.  
*Incoming phone call:* Answer

**8** **MUTE**  
 Mute sound.

**10** **LOUD**  
 Change the loudness level.

**11** **CLK**  
 Short press: Shows the clock.  
 Long press: Turn off the display.

**12** **SELECT**  
 Select / enter.

**13** **PLAY / PAUSE**  
 Play / pause track.

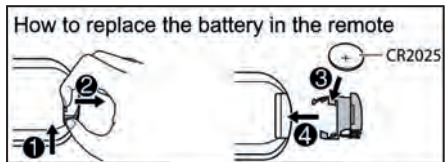

# HOW TO

A well-built sound system will set you aside from the rest and elevate your vehicle! It's important that you carefully read the instructions on the following pages. This is to make sure that you use the head unit correctly, for the true MAX EXPERIENCE!

## QUICK START

1) Press  to start the head unit.

### 2) Set Clock and Date

- Press Volume knob. Turn until the **[SYSTEM]** menu is shown.
- Press Volume knob to enter the menu.
- Turn Volume knob right to **[CLOCK]**
- Turn Volume knob right to **[CLOCK ADJUST]**
- Turn Volume knob to set Hour. Confirm by press volume knob. Repeat for Minutes.
- Press Search/Back
  
- Turn Volume knob right to **[CLOCK]**, press the volume knob to confirm.
- Turn Volume knob right to **[DATE SET]**
- Turn Volume knob to set date, month, year. Confirm by pressing Volume knob.
- Press Search/Back three times.

### 3) Turn of DEMO-mode

- Press Volume knob. Turn until the **[SYSTEM]** menu is shown.
- Press Volume knob to enter the menu.
- Turn Volume knob right until **[DEMO MODE]** shows up. Press Volume knob to enter.
- Chose "OFF"

### 4) Bluetooth Pairing

- Press SCR until **[BT MODE]** shows in the display
- Open Bluetooth settings on your mobile device.
- Find "MAX M140BTX"
- Connect your mobile device to the head unit.

### 5) Remote control

- Remove the insulation sheet between the battery and the power connectors.

# HOW TO

## **GAS HRC app control**

To get full control of your head unit and sound system, we recommend that you download the GAS HRC app. The app connects and controls compatible GAS receivers via Bluetooth. Key features include remote control, receiver setting and display information. Make smooth adjustments to your audio settings from outside your vehicle. Consult the App Store and/or Google Play instructions for more information.



## **Turn ON/OFF head unit via vehicle ignition**

If the car audio system is connected with the vehicle ignition, turning off the ignition key also switches off the device. Switching on the ignition will turn on the device.

## **Memory function**

The head unit has a memory function to store radio channels. The radio channels are stored when the power is turned off and will be shown again once the power is turned on.

## **Volume adjustments**

The volume on the head unit can be adjusted in steps from 0 (min) to 62 (max). Simply adjust the volume either by turning the volume knob on the unit or use the included remote control.

## **Storing radio station**

Select the desired preset with the BAND-button. Set the desired station by pressing one of the preset buttons [1]-[6] for approximately 3 seconds to store the current station at the button. Up to 6 stations can be stored in each bank (there are 3 banks), so up to 18 stations can be stored in total. Press the BAND-button to change memory bank, press the preset buttons [1]-[6] to choose the stored station.

## **USB/MicroSD media playback**

The car audio system can be used to play MP3 files as well as MP3, WMA, ACC, WAV & FLAC files on USB drive. Turn off the car audio system before removing the USB/MicroSD. The source USB/MicroSD is automatically chosen when it is plugged into the head unit. Use the preset buttons [1]-[2] on the head unit to browse through folders. Preset button [3] gives you repeat options (RPT Track, RPT Folder, RPT OFF) and preset button [4] gives you the option to random the playing order of the tracks. Preset button [5] is for Play/Pause and preset button [6] plays the first 10 sec of the chosen track.

# HOW TO

## DAB+ radio

DAB is a digital radio broadcasting system available in some countries and regions that delivers the radio signal digitally without annoying interference or signal distortion. To automatically scan and store the DAB+ radio stations with the strongest signal, press and hold the search button [3] for 3 seconds when the DAB+ radio is selected as source. To display the stored stations /channels, press the search button [3] - the preset stations /channels 1-6 will flash on the display for 10 seconds. To select a preset station /channel, press the preset button [1]-[6]. If you wish to manually scan for a station/channel, press the forward button [10] repeatedly. To store a station/channel, press and hold one of the preset buttons [1]-[6] until the frequency blinks on the display.

## DAB+ radio antenna

Find the best cable routing before placing the antenna, preferably along the car A-pillar. Be careful removing the A-pillar cover so that you do not damage the clips that holds the cover in place. Keep the antenna cable separate from other cables and do not overlap them. Install the antenna along your car's A-pillar so that the ground sheet of the antenna booster touches the metal frame of the car.

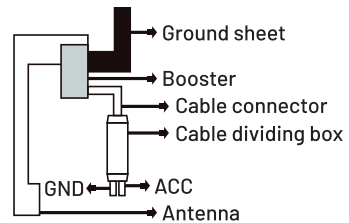

Without removing the adhesive film, hold antenna against the inside of the windshield and make sure that your windshield does not block out radio signals (IR reflecting glass / mirror film). Clean the area where you wish to place the antenna, the windshield needs to have a warm (normal) temperature for the adhesive to stick. When you remove the film from the adhesive, make sure that the adhesive does not touch any other surfaces but the dedicated area.

## DAB ANTENNA ON WINDSHIELD

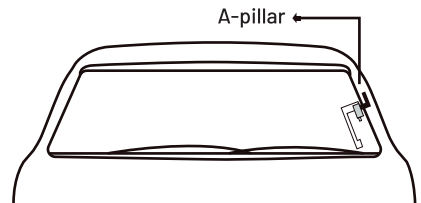

## Menu options

In the head units main menu there are several settings and options that you can adjust. To get to the main menu, press the volume knob. To browse in the menu, turn the volume knob and press it to select the high lighted menu option. In the menu you will find these options:

- Easy audio
- EQ settings
- Audio control
- Tuner
- Bluetooth
- System

# HOW TO

## EASY AUDIO

This menu setting includes options to adjust the performance of the sound system and the audio. Turn the volume knob to browse the menu and select the EASY AUDIO option. There are five different settings you can adjust. When you have selected a setting, turn the volume knob to change the value. Push the volume knob to confirm the change. Press the Search/Back button on the unit to go back to previous menu.

MENU SETTING	FUNCTION	VALUES
[SW LEVEL]	Subwoofer level.	[-15]-[0]-[+15](1 steps)
[PRESET EQ]	Select equalizer curve from 4 different EQ presets. (Create customs in PRO EQ)	Custom, Flat, Rock, Pop, Jazz
[FADER]	Adjust the relative level between front and back speakers.	[R15]-[0]-[F15](1 steps)
[BALANCE]	Adjust the relative level between left and right speakers.	[L15]-[0]-[R15](1 steps)
[LOUDNESS]	Raises lower and higher frequencies. Only use on low volumes.	OFF, LEVEL 1, LEVEL 2



# HOW TO

## EQ SETTINGS

This menu setting includes options to adjust the settings of the sound systems frequency response, by changing the equalizer. Use the volume knob to browse the menu and select the EQ SETTINGS option, by pushing the volume knob. There are two different settings you can adjust. When you have selected a setting, turn the volume knob to change the value. Push the volume knob to confirm the change. Press the Search/Back button on the unit to go back to previous menu.

### PRO EQ

Creates a custom equalizer curve that can be used in the [PRESET EQ] setting.

Equalizer bands are selected in the following order:

**50Hz - 62.5Hz - 80Hz - 100Hz - 125Hz - 200Hz - 250Hz - 315Hz - 400Hz - 500Hz - 630Hz - 800Hz - 1.25kHz - 2kHz - 3.15kHz - 5kHz - 6.3kHz - 10kHz - 12.5kHz - 16kHz**

By pressing the Volume knob while standing on a freq, you access the [LEVEL] menu of the band. Each band can be individually adjusted in level by [-9] to [+9] dB

### Q-FACTOR

The Q-factor changes the bandwidth of the frequency used in the [PRO EQ] setting. (See graphs below). The Q-factor can be changed with the values 2-4.

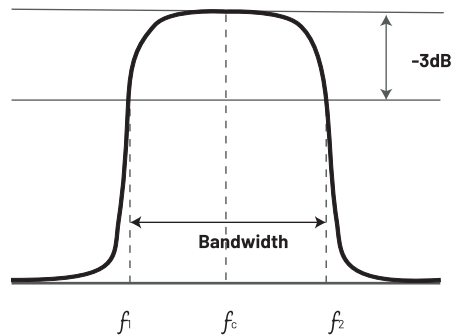
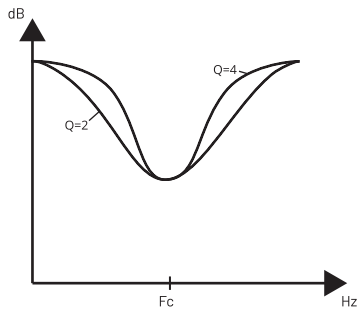



# HOW TO

## AUDIO CONTROL

This menu includes options to adjust the main settings of the sound system. Use the volume knob to browse the menu and select the AUDIO CONTROL option. There are four different menu that you can adjust. Some with several sub menus. When you have selected a setting, push the volume knob to enter the menu. Turn the volume knob to change the value. Push to confirm the adjustment. Press the Search/Back button on the unit to go back to previous menu.

MENU SETTING	FUNCTION	VALUES
[SUBW SET]	Subwoofer Pre-out.	OFF, ON
[BASS BOOST]	Set Bass Boost. Enhance lower bass at low volume. @80 Hz. <b>Handle with care!</b>	OFF, LEVEL 1, LEVEL 2, LEVEL 3, LEVEL 4, LEVEL 5
[X-OVER]	Choose x-over setting with either 2- or 3-way option. (Check HOW TO x-over)	(See the HOW TO X-OVER section on following pages)
[DELAY SETTINGS]	Gives a better synchronized audio playback. (Check HOW TO delay set.)	(See the HOW TO DELAY SETTINGS section on following pages)

# HOW TO

## UNDERSTANDING X-OVER

Adjusting crossover settings is the key when it comes to sound optimization. The crossover function gives you a great variety of options to customize your own settings, just for your sound system. Use the Notes page in the back of the manual to write down your crossover settings for future reference.

*Illustrated picture*

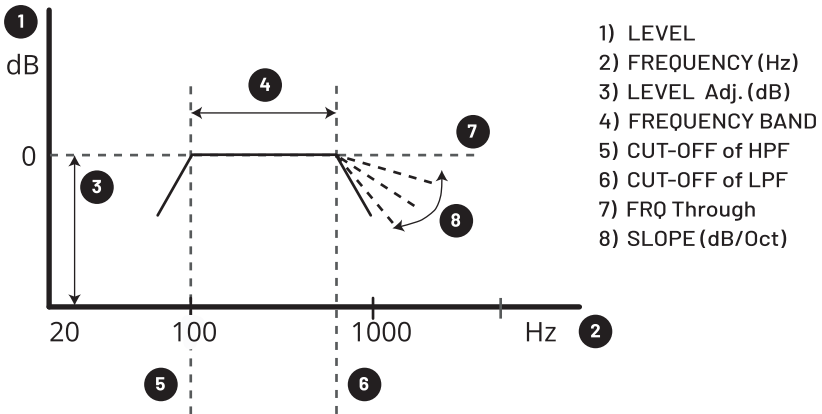

Using Cut-off of the HPF (High-Pass Filter) or LPF (Low-Pass Filter) gives you the possibility to adjust the frequency range for each line out.

- **HPF - High Pass filter** lets the high frequencies pass and cuts off the lower frequencies.
- **LPF - Low Pass filter** lets the low frequencies pass and cuts off the higher frequencies.
- **Pass through** - No filter is used
- HPF and LPF can be combined to create a **Band Pass filter**
- **Level:** Adjusts the different levels between the outputs.
- **Slope:** Lets you adjust the frequency range for each output. The slope shows how many decibels that the signal is dropping when the frequency is one octave lower (or higher). How many dB/oct. the signal is dropping for each unit. Adjustable between 6, 12, 18 & 24 dB/oct.

# HOW TO

## UNDERSTANDING X-OVER

• **Phase:** By changing phase (normal, reverse) you can adjust the signal between 0 and 180 degrees. Reversing the phase can improve the sound around the crossover frequency.

• **Q-Value:** A low Q value will give you a wide band and affect more frequencies. A high Q value will give you a more narrow band and is great to cut or boost more specific frequencies. For Low/High Pass filters and Shelving filters, a high Q value will add a more defined "bump" at the frequency position. This results in a small boost or a more resonant sound with extreme values.

**Calculate the Q-value:**

$$Q = Fc / \text{Bandwidth (-3dB point)}$$

Fc = Center frequency

Bandwidth = From start to stop frequency

GAIN determines the level of the peak (dip)

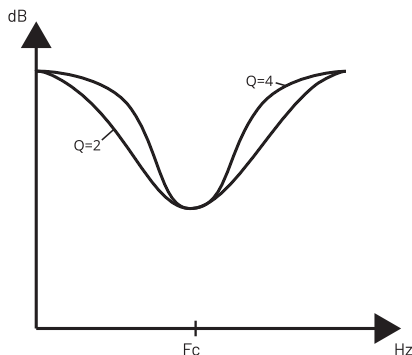

## X-OVER TYPE

<b>TYPE:</b>	2-way crossover	<b>VALUES:</b>	NO, YES
<b>TYPE:</b>	3-way crossover	<b>VALUES:</b>	NO, YES

# HOW TO

## X-OVER 2-WAY SETTINGS

<b>Tweeter (shelf)</b> This function lowers the level of all frequencies above the chosen frequency	EQS FRQ	1, 1.6, 2.5, 4, 5, 6.3, 8, 10, 12.5, 16 KHz
	EQS GAIN LEFT	-8, -7, -6, -5, -4, -3, -2, -1, 0 dB (1 steps)
	EQS GAIN RIGHT	-8, -7, -6, -5, -4, -3, -2, -1, 0 dB (1 steps)
<b>Front HPF</b> High pass filter for front speakers	HPF FRQ	30, 40, 50, 60, 70, 80, 90, 100, 120, 150, 180, 220, 250, 315, 400, 500 Hz, FRQ Through
	HPF SLOPE	6,12,18,24 dB/Oct
	HPF GAIN	-8, -7, -6, -5, -4, -3, -2, -1, 0 dB (1 steps)
<b>Rear HPF</b> High pass filter for rear speakers	HPF FRQ	30, 40, 50, 60, 70, 80, 90, 100, 120, 150, 180, 220, 250, 315, 400, 500 Hz, FRQ Through
	HPF SLOPE	6,12,18,24 dB/Oct
	HPF GAIN	-8, -7, -6, -5, -4, -3, -2, -1, 0 dB (1 steps)
<b>SUBW LPF</b> Low pass filter for subwoofer	LPF FRQ	30, 40, 50, 60, 70, 80, 90, 100, 120, 150, 180, 220, 250 Hz, FRQ Through
	LPF SLOPE	6,12,18,24 dB/Oct
	LPF PHASE	Normal/Reverse
	LPF GAIN	-8, -7, -6, -5, -4, -3, -2, -1, 0 dB (1 steps)



# HOW TO

## X-OVER 3-WAY SETTINGS

### **Tweeter** (pre-out front)

High pass filter for tweeters  
(EQS FRQ same as shelf in 2-way mode)

EQS FRQ	1, 1.6, 2.5, 4, 5, 6.3, 8, 10, 12.5 Khz, 16kHz FRQ Through
EQS GAIN L	-8, -7, -6, -5, -4, -3, -2, -1, 0 dB (1 steps)
EQS GAIN R	-8, -7, -6, -5, -4, -3, -2, -1, 0 dB (1 steps)
HPF FRQ	100, 120, 150, 180, 220, 250, 315, 400, 500, 630, 800 Hz, 1, 1.6, 2.5, 4, 5, 6.3, 8, 10, 12.5 kHz, FRQ Through
SLOPE	6,12,18,24 dB/Oct
PHASE	Normal/Reverse
GAIN	-8, -7, -6, -5, -4, -3, -2, -1, 0 dB (1 steps)

### **Midrange** (pre-out rear)

High and Low pass filter for midrange

HPF FRQ	30,40,50,60,70,80, 90, 100, 120, 150, 180, 220, 250, 315, 400, 500 Hz, FRQ Through
HPF SLOPE	6,12,18,24 dB/Oct
LPF FRQ	100, 120, 150, 180, 200, 250, 315, 400, 500, 630 800 Hz 1, 1.6, 2.5, 4, 5, 6.3, 8, 10, 12.5, 16 Khz, FRQ Through
LPF SLOPE	6,12,18,24 dB/Oct
M PHASE	Normal/Reverse
M GAIN	-8, -7, -6, -5, -4, -3, -2, -1, 0 dB (1 steps)



# HOW TO

## X-OVER 3-WAY SETTINGS

**Woofers** (pre-out subwoofer)  
Low pass filter for subwoofer

LPF-FRQ	30, 40, 50 60, 70, 80, 90, 100, 120, 150, 180, 220, 250, 315, 400, 500 Hz, FRQ Through
W SLOPE	6,12,18,24 dB/Oct
W PHASE	Normal/Reverse
W GAIN	-8, -7, -6, -5, -4, -3, -2, -1, 0 dB (1 steps)

# HOW TO

## UNDERSTANDING DELAY SETTINGS

Delay settings (time alignment) sets the delay time and relative phase to each speaker to create a more correct (time-domain) audio presentation, since the speakers are mounted at different distances from the sweet spot.

### How to set time alignment manually

1. Determine the reference point (RP)
2. Measure the distance from the reference point to the speaker furthest away (normally the subwoofer or rear speakers). This is the reference distance. If you are using a mono amplifier for your subwoofer, both SUB L & SUB R must have the same value.
3. Set the measured distance in [DISTANCE] for subwoofer.
4. Measure the distance from the reference point to the other speakers.
5. Set the measured distance [DISTANCE] for each speaker.
6. Adjust [GAIN] for each speaker. Close nearby speakers normally needs a lower (negative) value.

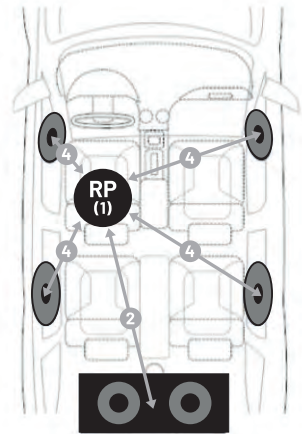

Hint: All similar speakers (E.g. tweeter/ midrange etc. ) should have the same perceived sound level at the listening position, for left and right channel.

# HOW TO

## DELAY SETTINGS

### Default settings 2-way

All (1,2,3,4)	All 110cm, 0dB		
Front Left (1)	FL 100cm, -2dB, FR 140cm, 0dB,	RL 80cm, -4dB, RR 120cm, -2dB,	SUB L 150cm, 0dB SUB R 150cm, 0dB
Front Right (2)	FL 140cm, 0dB, FR 100cm, -2dB,	RL 120cm, -2dB, RR 80cm, -4dB,	SUB L 150cm, 0dB SUB R 150cm, 0dB
Front (1,2)	FL 120cm, 0dB, FR 120cm, 0dB,	RL 100cm, -2dB, RR 100cm, -2dB,	SUB L 120cm, 0dB SUB R 120cm, 0dB

### POSITION

Default time alignment settings for different listening positions

ALL (1,2,3,4)  
Front Left (1)  
Front Right (2)  
Front (1,2)

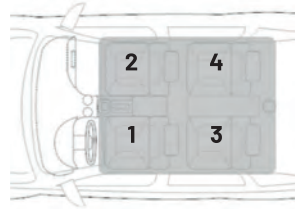

### DISTANCE: 2-WAY X-OVER

Set the distance between the speakers and listening position to get correct time alignment.

FRONT L	0-610cm (1cm steps)
FRONT R	0-610cm (1cm steps)
REAR L	0-610cm (1cm steps)
REAR R	0-610cm (1cm steps)
SUB L	0-610cm (1cm steps)
SUB R	0-610cm (1cm steps)

### GAIN: 2-WAY X-OVER

Set gain to increase and decrease the level on the speakers.

FRONT L	-8, -7, -6, -5, -4, -3, -2, -1,
FRONT R	0 dB (1 steps)

Hint: If the reference point is at the driver's position, all the speakers on the left side should be lower in gain.

REAR L	-8, -7, -6, -5, -4, -3, -2, -1,
REAR R	0 dB (1 steps)

SUB L	-8, -7, -6, -5, -4, -3, -2, -1,
SUB R	0 dB (1 steps)



# HOW TO

## DELAY SETTINGS

<b>Default settings 3-way</b>			
All (1,2,3,4)	TL 110cm, 0dB, TR 110cm, 0dB,	ML 110cm, 0dB, MR 110cm, 0dB,	SUB L 110cm, 0dB SUB R 110cm, 0dB
Front Left (1)	TL 100cm, -2dB, TR 140cm, 0dB,	ML 110cm, -2dB, MR 140cm, 0dB,	SUB L 150cm, 0dB SUB R 150cm, 0dB
Front Right (2)	TL 140cm, 0dB, TR 100cm, -2dB,	ML 140cm, 0dB, MR 110cm, -2dB,	SUB L 150cm, 0dB SUB R 150cm, 0dB
Front (1.2)	TL 110cm, 0dB, TR 110cm, 0dB,	ML 110cm, 0dB, MR 110cm, 0dB,	SUB L 150cm, 0dB SUB R 150cm, 0dB
<b>DISTANCE: 3-WAY X-OVER</b>			
Set the distance between the speakers and listening position, to get correct time alignment.	Tweeter L	0-610cm (1cm steps)	
	Tweeter R	0-610cm (1cm steps)	
	Midrange L	0-610cm (1cm steps)	
	Midrange R	0-610cm (1cm steps)	
	Woofer L	0-610cm (1cm steps)	
	Woofer R	0-610cm (1cm steps)	
<b>GAIN: 3-WAY X-OVER</b>			
Set gain to increase and decrease the level on the speakers.	Tweeter L	-8, -7, -6, -5, -4, -3, -2, -1, 0 dB (1 steps)	
	Tweeter R		
<u>Hint:</u> If the reference point is at the driver's position, all the speakers on the left side should be lower in gain.	Midrange L	-8, -7, -6, -5, -4, -3, -2, -1, 0 dB (1 steps)	
	Midrange R		
	Woofer L	-8, -7, -6, -5, -4, -3, -2, -1, 0 dB (1 steps)	
	Woofer R		
<b>DELAY RESET</b>			
Resets all delay settings.	NO / YES		



# HOW TO

## FM TUNER

This menu setting includes options to adjust the settings of the head unit's FM radio. Use the volume knob to browse the menu and select the FM TUNER option. There are nine different settings you can adjust. When you have selected a setting, turn the volume knob to change the value. Press the Search/Back button on the unit to go back in the menu.

MENU SETTING	FUNCTION	VALUES
[REGION]	Region in the world.	EUROPA, RUSSIA, ASIA, USA
[MONO SET]	Improves the FM reception, but the stereo effect may be lost.	OFF, ON
[LOCAL SEEK]	Only stations with a strong signal are found during the seek tuning.	OFF, ON
[REGIONAL]	Changes only to alternate frequencies of the station with same regional broadcasting.	OFF, ON
[RDS]	(Radio Data System) signal with additional functions, like displaying the name of the radio station.	OFF, ON
<b>NOTE!</b> The following settings are only visible when the RDS setting is ON		
[AF SET]	Maintain the station while switching between radio transmitters on the route.	OFF, ON
[DTA SET]	Digital time alignment.	OFF, ON
[NEWS SET]	Play news when PTY is on.	OFF, ON
[PTY SEARCH]	Programme type search.	PTY NONE, NEWS, AFFAIRS, INFO, SPORT, EDUCATION, DRAMA, CULTURE, SCIENCE, VARIED, POP, ROCK, EASY, LIGHT, CLASSICS, OTHER, WEATHER, FINANCE, CHILDREN, SOCIAL, RELIGION, PHONE IN, TRAVEL, LEISURE, JAZZ, COUNTRY, NATION, OLDIES, DOCUMENT

# HOW TO

## BLUETOOTH

This menu setting includes options to adjust the settings of the head unit's Bluetooth function. Use the volume knob to browse the menu and select the BLUETOOTH option. There are three different settings you can adjust. When you have selected a setting, turn the volume knob to change the value. Press the Search/Back button on the unit to go back in the menu.

MENU SETTING	FUNCTION	VALUES
[RECONNECT]	Reconnect mobile device to the head unit automatically when it's in range.	OFF, ON
[INITIALIZE]	Cleans/wipes BT-memory. (Make sure to set the value to NO after connecting)	YES, NO
[INFORMATION]	Shows the Bluetooth name of the head unit. Press "MY BT NAME" in the menu.	MAX M140 BTX

# HOW TO

## BLUETOOTH FUNCTIONS

The Bluetooth® function allows pairing cell phones & BT equipped media playback devices with the car audio system. When you connect a cell phone with the car audio system, you can make phone calls with the built-in hands free function. You can access the last dialed number in you mobile device.

If the connected Bluetooth® device supports functions like A2DP and AVRCP, you can play music via the car audio system and control playback. During a call, music playback is interrupted and resumes again after the call.

If a cell phone is registered via Bluetooth® and a call is received during playback, the source playback is interrupted and the call menu is displayed. To get the best quality in the conversation, it's recommended to use the external microphone.

Connect the microphone to the head unit. To capture your voice during handsfree calling, you need to install the microphone. The cable is 2.95m long.

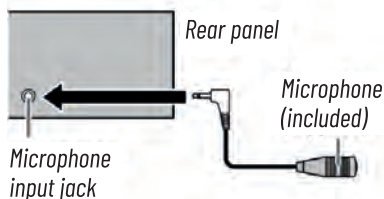

Mount the microphone as close to the driving position as possible. The cord must be safely installed.

### CONNECTING BLUETOOTH DEVICE

Press the SRC button until you get to the [BLUETOOTH] option. Find "MAX M150BDX" in the list of Bluetooth devices on your mobile phone and select it to connect.

### HANDS-FREE PHONE CALLS

GAS M150-BTX head unit handles hands-free phone calls with the external or internal microphone. When you receive an incoming phone call, you simply answer by pressing the ["PHONE"/ BAND] button on the head unit or the ["PHONE"/SRC] button on the remote control. To end the phone call you press the [DISP] button on the head unit or the [BAND] button on the remote control.

If you wish to make a phone call directly through the MAX M150-BDX head unit, press the ["PHONE"/ BAND] button on the unit to call the latest phone number in your call-log.

# HOW TO

## SYSTEM

This menu setting includes options to adjust the head unit's system settings. Use the volume knob to browse the menu and select the SYSTEM option. There are eight different settings you can adjust. When you have selected a setting, turn the volume knob to change the value. Press the Search/Back button on the unit to go back in the menu.

MENU SETTING: DISPLAY		
DISPLAY OPTION	FUNCTION	VALUES
[COLOR SETTINGS]	Choose color on the display text and buttons.	BLUE, RED, GREEN, PURPLE, YELLOW, CYAN, WHITE, Variable Auto
[DIMMER]	Preventing the display from being too bright at night.	OFF/ON, OFF: Brightness stays on DAY setting, ON: Brightness changes to NIGHT setting,
[BRIGHTNESS]	Settings for the different dimmer options.	DAY (0-15) / NIGHT (0-15)
[DISPLAY ILL]	Turns on/off the display.	OFF, ON
[BUTTON ILL]	Turns on/off button lights.	OFF, ON
[SPECTRUM]	Moving graphics on display.	OFF, ON
[ID3 TAG]	Only works on stored music such as MP3,FLAC, etc.	OFF, ON
[VERSION]	Installed software version	VER 05 - 006 (from factory)

# HOW TO

MENU SETTING: CLOCK		
DISPLAY OPTION	FUNCTION	VALUES
[CLOCK FORMAT]	Setting of clock format.	12H, 24H
[CLOCK ADJUST]	Change time on the display.	HH:MM:SS
[DATE FORMAT]	Setting of date format.	DD/MM/YY MM/DD/YY
[DATE ADJUST]	Change date on the display.	DD:MM:YY
[CLOCK DISPLAY]	Show time on the display.	OFF, ON

MENU SETTING	FUNCTION	VALUES
[LANGUAGE]	Language shown on display.	ENGLISH
[DATA RESET]	Reset the unit's settings to factory standards.	NO, YES
[BEEP]	Activate key press tone.	OFF, ON
[AMPLIFIER]	Use of internal amplifier.	OFF, ON
[DEMO MODE]	Use demo mode of the unit.	OFF, ON
[ANIMATION]	Speed settings of display animations.	PER 15 SEK, PER 30 SEK PER 1, 2, 4 MIN, OFF



# PERSONAL NOTES

Now that you've done your homework and know how to adjust your crossover settings, it is smart to write them down for future reference. Work smart, not harder, that way you will get the most out of your sound system and have the ultimate MAX EXPERIENCE!

Tweeter                      FREQ    \_\_\_\_\_

   SLOPE   \_\_\_\_\_

   PHASE   \_\_\_\_\_

   GAIN    \_\_\_\_\_

Midrange HPF                FREQ    \_\_\_\_\_

   SLOPE   \_\_\_\_\_

   PHASE   \_\_\_\_\_

   GAIN    \_\_\_\_\_

Midrange LPF                FREQ    \_\_\_\_\_

   SLOPE   \_\_\_\_\_

   PHASE   \_\_\_\_\_

   GAIN    \_\_\_\_\_

Woofers                      FREQ    \_\_\_\_\_

   SLOPE   \_\_\_\_\_

   PHASE   \_\_\_\_\_

   GAIN    \_\_\_\_\_



# TROUBLESHOOTING

## NO POWER

Check the head unit to make sure it isn't damaged. If your system doesn't get any power, the most common issue is either in the wiring or the fuse. Use a multimeter to measure the head unit voltages, both yellow and red cable (+12-16V)

Check that all speaker cables are connected to your sound system. If you are using a car specific cable harness, make sure it is for your car model. Most modern cars have some kind of CAN-Bus system to start the OEM head unit, for these cars a special CAN-Bus harness is needed. Make sure that the RCA cables are properly connected if external amplifier is used and that you have 12V remote on the external amplifier.

GAS MAX M150-BDX has a function to turn on/off the internal amplifier. Make sure it is on!

## UNWANTED NOISE

Start by looking over the speakers in the sound system so there is no damage or connection issue with the wiring. Make sure that your signal cables or speaker cables aren't too close to the power cables. If the noise changes with the accelerator, it is most certain a ground loop issue. Make sure that the grounding point is good, especially if an external amplifier is used.

When all of the above has been tested/looked over, and the unwanted noise does not vanish, consult your local GAS dealer.

## DISTORTION

Start by looking over the installation and all cables in the sound system so there's no damage or connection issue with the wiring. Check the speaker cables to make sure that the polarity isn't reversed on one channel. If an external amplifier is used, make sure that the gain/level is set according to the amplifier's instructions. If your amplifier has a boost function, lower its effect or turn it off.

GAS MAX M150-BDX have an advanced DSP with several settings, that used with uncorrect setting can make the setup sound less good. Reset the settings as a last option.





# WARRANTY & DISPOSAL

This product is covered by warranty, depending on the conditions in the country where it's sold. If the subwoofer is returned for service, please include the original dated receipt (or a copy) with the product. Make sure that the subwoofer is packaged properly and secured, preferably in its original packaging.



The crossed-out wheeie bin symbol means that the product, literature and packaging included must be taken to separate collection at the end of their working life. Don't dispose of these products as unsorted municipal waste: take them for recycling. For info on your nearest recycling point, check with your local waste authority.



This product has been granted with the CE certification mark to show that the product follows the health, safety, and environmental protection standards for products sold within the European Economic Area (EEA).



GAS Audio Power products comply with the relevant provisions of the RoHS Directive for the European Union. In common with all Electrical and Electronic Equipment (EEE) the product shouldn't be disposed of as household waste. Alternative arrangements may apply in other jurisdictions.



GAS Audio Power is a global partner of the European Mobile Media Association, an organization that focus on promoting the custom made mobile media installations to consumers.

# THE GAS WORLD

You've entered the world of GAS. We aim to please, and we've made sure to have products made for you. No matter what stage of the LOUD-addiction you might find yourself in, there is a GAS product to fill your need.

## ***MAD***

Just starting out? The MAD series is made to play LOUD and to be the express lane to a no bullsh!t sound system that will make sure everyone can hear you coming!

## ***MAX***

The MAX series holds products made to deserve the center stage. Powerful, heavy duty and designed to be noticed. We made NO COMPROMISES because we know that you wouldn't accept it.

## ***CMP***

The CMP series has been developed for the crucial seconds when the dB-counter starts to tick. All CMP products have hand-picked, high quality, COMPETITION GRADE components and they are specially designed to withstand an awesome amount of power.



# THANKS FOR JOINING GAS AUDIO POWER!



**GAS**  
**AUDIO POWER**

GAS AUDIO POWER and SHAKY are registered trademarks by Winn Scandinavia AB and is protected by relevant laws and jurisdictions such as Copyright and Trademark laws.

Winn Scandinavia AB | Elementvägen 15, 70227 Örebro, Sweden | [www.winnscandinavia.com](http://www.winnscandinavia.com)

Winn Scandinavia AB reserves for possible typos, factual or numeric errors that may have been printed on any products, package designs, user manuals and/or other included accessories.

Winn Scandinavia AB can't guarantee flawless function/performance of our products together with third-party accessories and products like USB data carriers, MicroSD cards, cables, etc.

**GAS**  
AUDIO POWER