



UNI-SWC.5 Universal Steering Wheel Control Interface



- i. UNI-SWC.5 Interface
- ii. Head Unit Connection (Patch) Lead
- iii. UNI-SWC.5 Wiring Harness

Designed and
Engineered
in the UK. 

APPLICATION

Note: Application data is subject to change at any time

- **900+ Vehicle Applications***

*Please note: application data is constantly being improved and amended as we expand the product's capabilities. Please visit www.connects2.com for the most up to date information and data regarding this interface.

FEATURES

- **Compatible with 900+ Vehicle Applications**
- **Works with Vehicles on Analogue, CAN-Bus, iBus, Class II and Matrix Platforms**
- **Retains Factory Steering Wheel Control Functions including Phone Buttons**
- **Allows Time/Date Change from Steering Wheel (*select models only*)**
- **Supports Voice Assistant (*select models only*)**
- **Analogue Learning System**
- **Button Remapping Feature**
- **Supports ACC, Illumination, Speed Pulse, Park Brake & Reverse Gear**
(*where vehicle data allows*)
- **Updateable via USB (*contact supplier for more information*)**

DISCLAIMER

The information provided in this document is subject to change without notice due to manufacturer changes and/or improvements to the product/s. This instruction manual is based on documented data and research. The manufacturer of this product cannot be held responsible for any changes made to the vehicle by the manufacturer or damages that may occur through the installation of this product in accordance with the steps outlined herein.

CONTENTS

I.	ABOUT	3
II.	PRIOR TO INSTALLATION	3
	a. CONNECTION DIAGRAM	3
	b. PREPARING THE PATCH LEAD	4
	c. SETTING THE DIPSWITCHES	4
	d. REMAPPING FUNCTIONS	4
III.	INSTALLATION	5
	a. STEP GUIDE	5
	b. PROGRAMMING THE INTERFACE	6
	c. ANALOGUE LEARNING HEAD UNITS	7
VI.	REMAPPING SOFTWARE	8
VII.	APPLICATION	9
	a. PRELIMINARY	9
	b. APPLICATION GUIDE	10
	c. ACCESSING SETTINGS MENUS	26
	d. DIAGRAM CHART	28

I. ABOUT

The UNI-SWC.5 interface is a universal steering wheel control solution designed to retain the steering wheel control functionality of a vehicle when the factory stereo is upgraded to an aftermarket model. The interface is compatible with over 900 vehicle applications across a variety of platforms and allows for the remapping of button functionality through a bespoke PC application.

II. PRIOR TO INSTALLATION

a. Connection Diagram

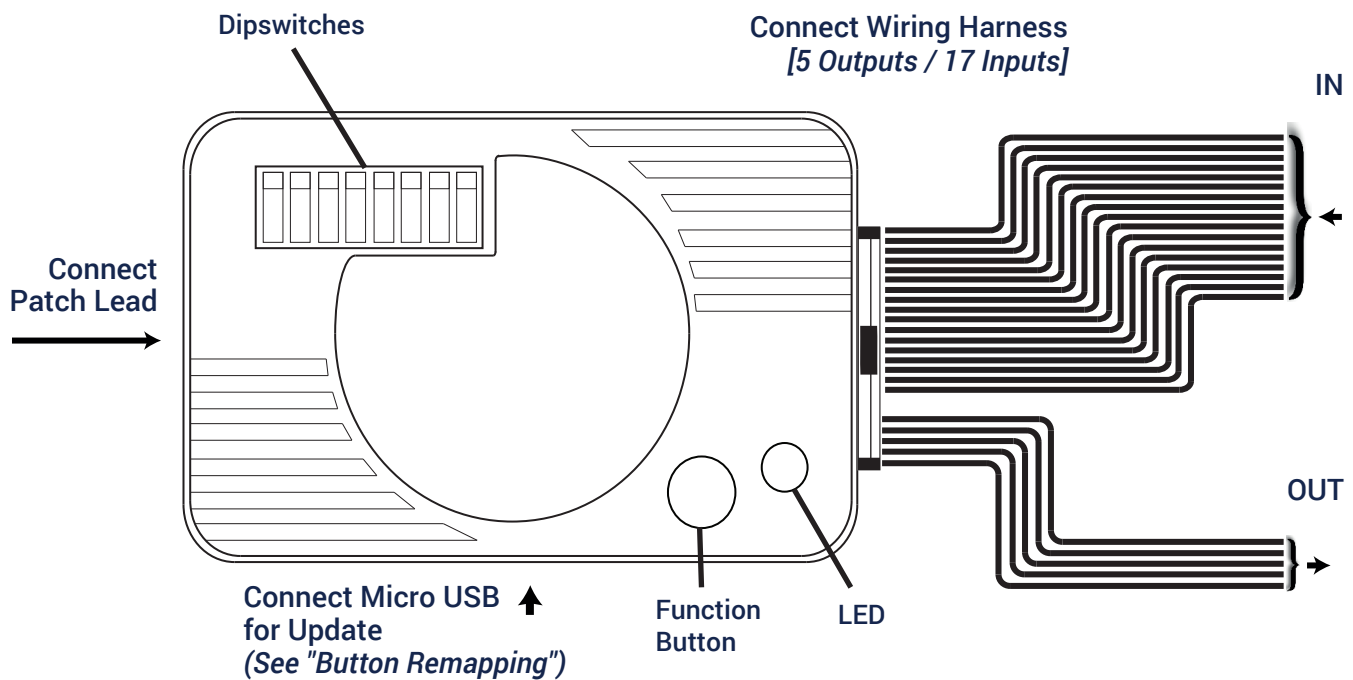

OUT

Red/White	Acc. 12V
Orange	Illumination
Purple/White	Reverse Gear
Lt. Green	Park Brake
Lt. Pink	Speed Pulse

IN

Green/Black	IN1	Purple	IN11
Blue	IN2	Blue/White	IN12
White	IN3	Green/White	IN13
Orange/Black	IN4	Grey/Black	IN14
Red	IN5	Pink/Black	IN15
Green	IN6	Black	Ground
White/Black	IN7	Yellow	Batt 12V
Grey	IN8		
Black/White	IN9		
Yellow/Black	IN10		

b. Preparing the Patch Lead

The UNI-SWC.5 comes complete with a universal head unit connection/patch lead to provide compatibility with nearly every brand of aftermarket stereo on the market. Follow the instructions and table below to prepare the patch lead for installation based on the brand/type of stereo being installed into the vehicle.

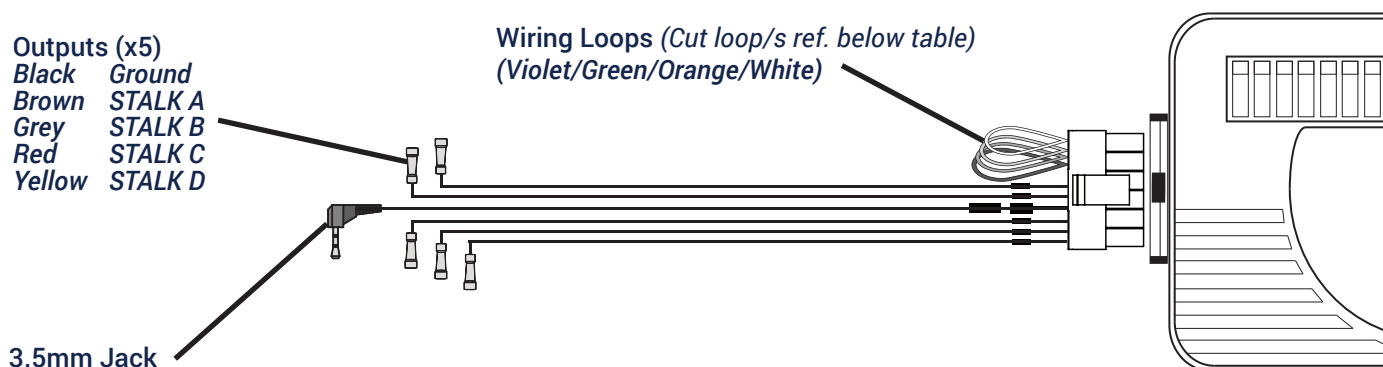

Stereo Brand	Loop Configuration	Stereo Connection
Alpine	Cut Green Loop	3.5mm Jack
Clarion	Cut Violet Loop	3.5mm Jack
JVC	Cut Green & Violet Loop	3.5mm Jack or Stalk A
Kenwood	Cut Orange & Green Loop	Stalk A
Panasonic	Cut Orange Loop	Stalk A
Pioneer	Cut White Loop	3.5mm Jack
Sony	No Cut Required	3.5mm Jack
Analogue Learning Units*	No Cut Required	Stalk C / Stalk D / Ground

**If an analogue learning stereo is being installed in the vehicle, please refer to Pg. 7. for more information*

iii. Setting the Dipswitches

The UNI-SWC.5 interface has 8 individual dipswitches. Please set the dipswitches according to the information in the 'Application Guide' section (Pages 10 - 26) of this instruction manual.

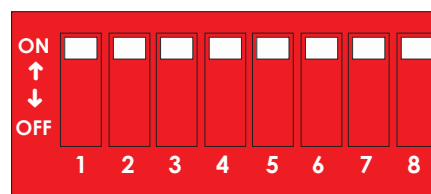

iv. Remapping Functions

The UNI-SWC.5 can be programmed to configure any vehicle function to any button, on either a long or short press. To begin button remapping, plug the interface into a computer via the Micro USB port and load up the SWC configuration software. If this step is skipped, a default configuration will be used.

Please see Pg. 8 for more information on how to remap button functionality.

III. INSTALLATION

a. Step Guide

Note: Prior to installation, ensure all required steps from the previous section have been completed, including preparing the patch lead, setting the interface dipswitches and remapping the button configuration (if desired).

Vehicle model not supported??

Note: Some vehicles on Analogue, Class II, and GM 11 platforms include steering wheel control functions that must be learned by the interface. Please refer to Pg. 6 for programming instructions prior to installation

- 1** Remove and disconnect the original head unit. Please see the vehicle owners' manual for more information.
- 2** Connect the Patch Lead to the UNI-SWC.5 Interface
- 3** Connect the patch lead to the aftermarket stereo, based on the brand/type of stereo being installed. (See 'Stereo Connection' column in table on Pg. 4).
- !!** **IMPORTANT: STEP 3 MUST BE COMPLETED BEFORE CONNECTING POWER TO THE INTERFACE. FAILURE TO DO SO MAY RESULT IN A LACK OF FUNCTIONALITY AND THE NEED TO REINSTALL THE PRODUCT.**
- 4** Find the desired vehicle application in the 'Application Guide' section of this manual. The row will contain information about how to correctly set up and wire the interface.
- 5** Locate the relevant diagram number in the table. This diagram number refers the 'Diagram Chart' section at the back of this manual. Refer to the diagram referenced to find the locations of the wiring within the connector.
Note: All connector diagrams are shown from the terminal side, not the wiring side. Please take this into consideration when wiring this product.
- 6** Connect the UNI-SWC.5 Wiring Harness to the UNI-SWC.5 Interface
- 7** Install the interface into the vehicle, connecting Permanent 12V and Ground to suitable locations and then wiring it using the information found in the Application Guide and Diagram Chart sections of this instruction manual. IN5 must also be connected to a suitable switched 12V feed in the vehicle where indicated by the Application Guide table.
- 8** Test interface for correct operation and reinstall the head unit.

Note: Car manufacturers can change wiring specifications without notice. Please ensure that the correct wires are located before commencing installation

b. Programming the Interface

When installing the UNI-SWC.5 into a currently unsupported Analogue, Class II or GM 11 vehicle, the interface must first 'learn' the buttons on the vehicle steering wheel.

Please follow the below steps to correctly configure the interface for use with the vehicle:

Set-Up

Please note that if the vehicle is also included in the 'Application Guide' section of this manual, the wiring in the table there must be connected in addition to the wiring below.

1. Connect the Ground wire (Black) from the UNI-SWC.5 Wiring Harness to the vehicle ground
2. Connect the IN5 wire from the UNI-SWC.5 Wiring Harness to the vehicle (if required)

Note: Some applications do not require IN5 to be connected. Please see 'Application Guide' section for information on whether to connect this wire, and if so, where to connect it in the vehicle.

3. Connect BATT 12V wire (Yellow) from the UNI-SWC.5 Wiring Harness to the 12V battery supply from the vehicle
4. Connect the relevant wiring to the vehicle depending on the vehicle platform (see 'Platform Guide' below)
5. Set Dipswitches depending on the vehicle platform (See 'Platform Guide' below)
6. The LED on the front of the interface will slowly glow green
7. Press and hold the **Function Button** for 5 seconds
8. The LED will flash red and then green

The interface is now ready to be programmed

Platform Guide

For Full Analogue Learning Vehicles

Set Dipswitches 1 - 8 to 'On'

Connect IN6 and IN7 from the UNI-SWC.5 Wiring Harness to the vehicle

1 1 1 1 1 1 1 1

For Class II Analogue Vehicles

Set Dipswitches 1,2,3,4,5,6,8 to 'On', 7 to 'Off'

Connect IN10 from the UNI-SWC.5 Wiring Harness to the vehicle

1 1 1 1 1 1 0 1

For GM 11 BIT (w/out RAP) Analogue Vehicles

Set Dipswitches 1,2,3,4,5,7 to 'On', 6 and 8 to 'Off'

Connect IN10 from the UNI-SWC.5 Wiring Harness to the vehicle

1 1 1 1 1 0 1 0

For GM 11 BIT (with RAP) Analogue Vehicles

Set Dipswitches 1,2,3,4,5,7,8 to 'On', 6 to 'Off'

Connect IN10 from the UNI-SWC.5 Wiring Harness to the vehicle

1 1 1 1 1 0 1 1

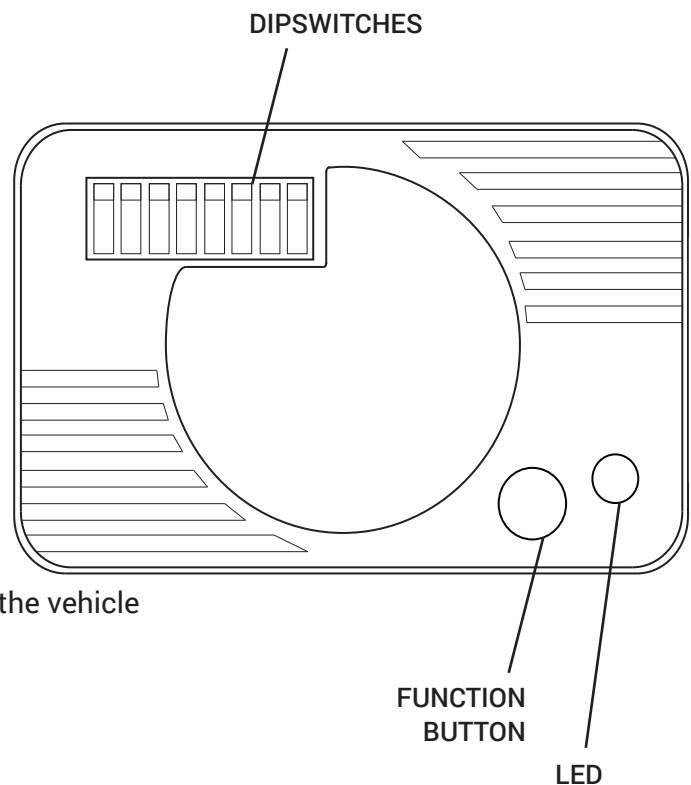

Programming

1. Start to program the buttons in the following order:

```
KEY_VOL_UP,  
KEY_VOL_DOWN,  
KEY_TRACK_UP,  
KEY_TRACK_DOWN,  
KEY_SOURCE,  
KEY_MUTE,  
KEY_DISK_UP,  
KEY_DISK_DOWN,  
KEY_PICKUP,  
KEY_HANGUP,  
KEY_PHONE, // Single Phone Button = Short Press - Pick Up / Long Press - Hang Up  
KEY_VOICE_RECOGNITION
```

2. Once a button value is seen, the **LED** will flash red, then move on to the next button by flashing green
3. If a key/button function is missing from the vehicle, press the **Function Button** to skip a key
4. Once complete, the LED will flash red twice and return to slowly glowing green
5. To restart the learning process from the beginning at any point, press and hold the **Function Button** for 5 seconds

c. Analogue Learning Head Units

Once the interface has been successfully connected to the vehicle, analogue learning head units will require the user to assign functions to the vehicle's buttons.

Analogue Learning Process

1. Once connected to the vehicle, the interface **LED** will slowly glow green.
2. Press the **Function Button** 10 times quickly*. The **LED** will now quickly flash red.
3. Program all buttons using the head unit's SWC learning menu and the vehicle's steering wheel control buttons.
4. When finished, press the **Function Button** 10 times quickly. The **LED** will return to a slow green glow.

**Note: By pressing the Function Button 10 times quickly, the interface is being put into a mode which allows it to stretch the outputs of the steering wheel control buttons. This allows the head unit to more effectively learn functions of buttons with a fast output time (ie. a scroll wheel). Although it is recommended that all buttons be programmed with this mode active to give the head unit a longer time to learn each output, Step 2 can be bypassed if desired, or activated only for learning specific buttons.*

VI. REMAPPING SOFTWARE

The UNI-SWC.5 can be programmed to configure any vehicle function to any button, on either a long or short press. To begin button remapping, plug the interface into a computer via the Micro USB port and load up the SWC configuration program (*visit www.connects2.com/home/news_downloads for more information*).

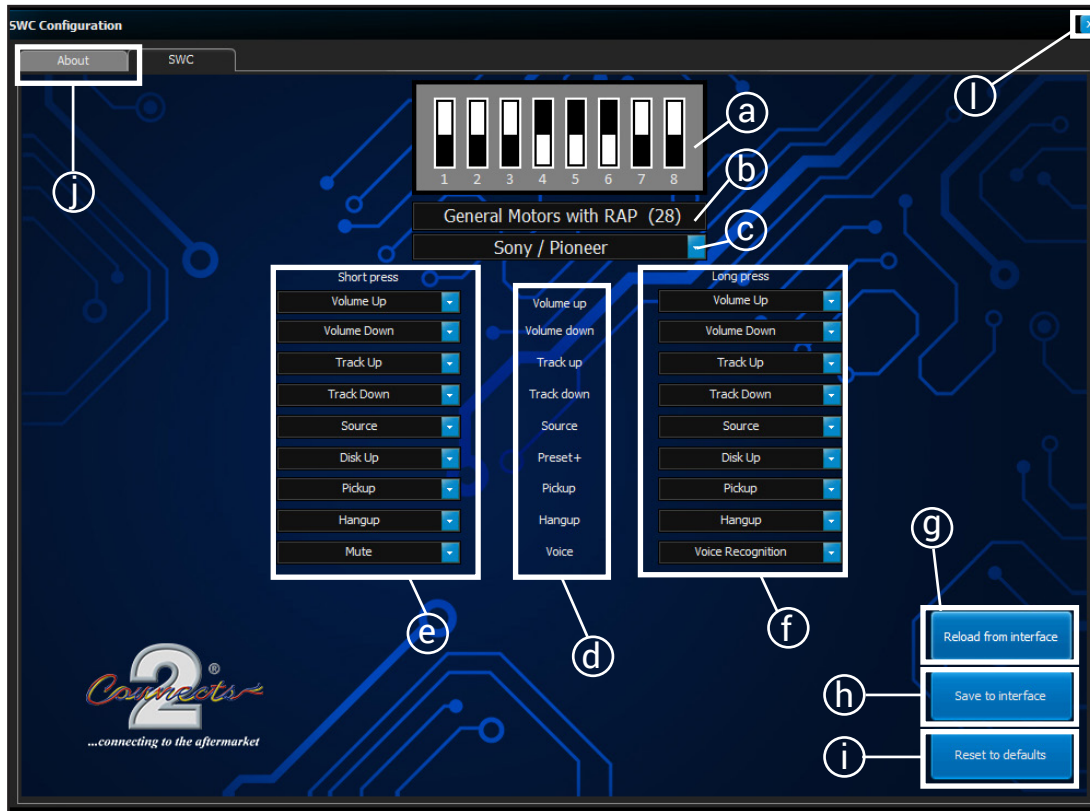

Set-Up

Upon connecting the interface, the software will correctly read its dipswitch settings (a) and display the vehicle's software platform (b).

Select the brand/type of aftermarket stereo from the drop-down list (c) and the central column will display all buttons available to program (d).

Remapping Buttons

Functions can be assigned as desired to each button by clicking on the drop-down arrows next to the menus in the left (e) and right (f) columns. The short press functionality of the button is dictated by the selection in the left column (e) and the long press functionality of the button is dictated by the selection in the right column (f).

For e.g.: In the above example, the vehicle's Voice button will function as Mute on a short press, and Voice Recognition on a long press.

Note: To reset the drop-down bars in the right and left columns to their default functions, press 'Reset to defaults' (i)

Saving Button Functions

To save the button configuration, press 'Save to interface' (h).

Reloading Default Configuration

To reload the configuration from the interface and overwrite any changes that have been made, press 'Reload from Interface' (g)

More Information and Exiting Software

To access more information about the software, press the 'About' tab (j).

To return to the configurator screen, press the 'SWC' tab.

Close the configurator window by pressing the 'X' icon (l)

VII. VEHICLE APPLICATION

a. Preliminary

Before locating your vehicle in the application tables, please familiarise yourself with the following items and their meanings:

Note: For Pontiac Solstice Vehicles

The Red/White Accessory OUT wire (ACC 12V) must be connected to the pin in car connector B, location 14 (Ref. Diagram 8).

Key	Column	Notes
1* - 7*	Menu Column	The vehicle menu can be accessed via the steering wheel controls and requires additional detail to explain functionality. Please consult the 'Accessing Settings Menu' pages of this manual (Pages 27-28).
S12V*	IN5	Connect to Switched 12V feed
**	Any Column	This vehicle has analogue steering wheel controls and must be programmed according to the specific instructions in this manual. Please consult the 'Programming the Interface' pages of this manual (Pages 6-7).
Tick/Cross	Any Column	The vehicle supports/does not support the function described.
TC	Any Column	'To Chassis'. Connect the input to a suitable point on the vehicle chassis
*PM	Ford Vehicles	The IN7 wire must be connected to the vehicle's phone module. Please see the vehicle owners manual for more information on how to locate the module.
iBus*	BMW Vehicles	A 4k7 resistor will need to be connected between the Batt 12V wire and the IN4 (iBus) wire
2PIN*	Saab Vehicles	The wire must be connected to the green wire in the 2 pin connector located under the steering wheel column (please note: the wire may need to be extended)



b. Application Guide

Note: Refer to Page 9 for further information on symbols used in these tables and how they relate to installation of the interface

Man.	Model	Year From	Year To	Phone Button Support	Voice Assistant Support	Menu	Platform	Dipswitch Setting (0 - Off / 1 - On)								Diagram No.	IN6	IN7	Ana. GND	IN2	IN3	IN5	IN1	IN4	IN8	IN9	IN13	IN14	IN15	IN10
								1	2	3	4	5	6	7	8															
Alfa Romeo	147	2000	2007	x	x	x	Analogue	0	1	1	1	0	1	0	1	0	1	20	33	27	Together	8	N/A	N/A	N/A	N/A	N/A	N/A	N/A	
	147	2007	2010	x	x	x	CAN/Analogue	0	1	1	1	0	1	1	0	1	0	20	33	27	5	N/A	N/A	N/A	N/A	N/A	N/A	N/A		
	147	2007	2010	✓	x	x	CAN	0	1	1	0	1	1	1	0	1	0	N/A	N/A	N/A	5	N/A	N/A	N/A	N/A	N/A	N/A	N/A		
	156	2000	2007	x	x	x	Analogue	0	1	1	1	0	1	0	1	0	1	20	33	27	Together	8	N/A	N/A	N/A	N/A	N/A	N/A	N/A	
	159	2005	2011	✓	✓	x	CAN	0	1	1	0	1	1	1	0	1	0	N/A	N/A	N/A	5	N/A	N/A	N/A	N/A	N/A	N/A	N/A		
	4C	2013	>	✓	✓	x	CAN	1	1	1	1	1	1	0	0	4	N/A	N/A	N/A	2	12	N/A	N/A	N/A	N/A	N/A	N/A	N/A		
	Breila	2005	2010	✓	✓	x	CAN	0	1	1	0	1	1	1	0	1	N/A	N/A	N/A	5	6	N/A	N/A	N/A	N/A	N/A	N/A	N/A		
	Giulietta	2010	2014	✓	✓	x	CAN	0	1	1	1	1	1	1	0	1	N/A	N/A	N/A	5	6	N/A	N/A	N/A	N/A	N/A	N/A	N/A		
	Giulietta	2014	>	✓	✓	x	CAN	1	1	1	1	1	1	0	0	1	N/A	N/A	N/A	5	6	N/A	N/A	N/A	N/A	N/A	N/A	N/A		
	Giulietta	2014	>	✓	✓	x	CAN	1	1	1	1	1	1	0	0	4	N/A	N/A	N/A	2	12	N/A	N/A	N/A	N/A	N/A	N/A	N/A		
	GT	2004	2008	x	x	x	Analogue	0	1	1	1	1	0	1	0	1	0	20	33	27	Together	8	N/A	N/A	N/A	N/A	N/A	N/A	N/A	
	GT	2008	2010	x	x	x	CAN/Analogue	0	1	1	1	0	1	1	0	1	0	20	33	27	5	N/A	N/A	N/A	N/A	N/A	N/A	N/A	N/A	
	Mito	2008	2014	✓	✓	x	CAN	0	1	1	1	1	1	0	1	0	1	N/A	N/A	N/A	5	6	N/A	N/A	N/A	N/A	N/A	N/A		
	Mito	2014	>	✓	✓	x	CAN	1	1	1	1	1	1	0	0	1	N/A	N/A	N/A	5	6	N/A	N/A	N/A	N/A	N/A	N/A	N/A		
	Mito	2014	>	✓	✓	x	CAN	1	1	1	1	1	1	0	0	4	N/A	N/A	N/A	2	12	N/A	N/A	N/A	N/A	N/A	N/A	N/A		
	A1	2010	>	✓	✓	x	CAN	1	1	0	1	1	1	1	0	5	N/A	N/A	N/A	23	17	N/A	N/A	N/A	N/A	N/A	N/A	N/A		
	A2	1999	2005	✓	✓	x	IR	0	0	0	0	1	0	1	1	1	N/A	N/A	N/A	Together	2	N/A	N/A	N/A	N/A	N/A	N/A	N/A		
	A3	2003	2005	✓	✓	x	Analogue	1	1	0	1	1	1	0	1	0	1	32	27	N/A	9	10	N/A	N/A	N/A	N/A	N/A	N/A		
	A3	2003	2013	✓	✓	x	CAN	1	1	0	1	1	1	1	0	2	N/A	N/A	N/A	Together	2	N/A	N/A	N/A	N/A	N/A	N/A	N/A		
	A3	1996	2003	✓	✓	x	IR	0	0	0	1	0	1	1	1	1	N/A	N/A	N/A	9	10	N/A	N/A	N/A	N/A	N/A	N/A	N/A		
	A3	2005	2012	✓	✓	x	CAN	1	1	0	1	1	1	1	0	2	N/A	N/A	N/A	9	10	N/A	N/A	N/A	N/A	N/A	N/A	N/A		
	A3	2005	2012	✓	✓	x	CAN	1	1	0	1	1	1	1	0	2	N/A	N/A	N/A	9	10	N/A	N/A	N/A	N/A	N/A	N/A	N/A		
	A4	2001	2008	✓	✓	x	Analogue	1	1	0	1	1	1	1	0	1	32	27	N/A	Together	N/A	N/A	N/A	N/A	N/A	N/A	N/A	N/A		
	A4	2001	2008	✓	✓	x	CAN	1	1	0	1	1	1	1	0	2	N/A	N/A	N/A	9	10	N/A	N/A	N/A	N/A	N/A	N/A	N/A		
A4	1994	2001	✓	✓	x	IR	0	0	0	0	1	0	1	1	1	N/A	N/A	N/A	Together	2	N/A	N/A	N/A	N/A	N/A	N/A	N/A			
A4	2000	2013	✓	✓	x	CAN	1	1	0	1	1	1	1	0	2	N/A	N/A	N/A	9	10	N/A	N/A	N/A	N/A	N/A	N/A	N/A			
A4	2001	2013	✓	✓	x	CAN	1	1	0	1	1	1	1	0	2	N/A	N/A	N/A	9	10	N/A	N/A	N/A	N/A	N/A	N/A	N/A			
A6	2004	2011	✓	✓	x	CAN	1	1	0	1	1	1	1	0	2	N/A	N/A	N/A	9	10	N/A	N/A	N/A	N/A	N/A	N/A	N/A			
A6	1994	2004	✓	✓	x	IR	0	0	0	0	1	0	1	1	1	N/A	N/A	N/A	Together	2	N/A	N/A	N/A	N/A	N/A	N/A	N/A			
A6	2004	2011	✓	✓	x	CAN	1	1	0	1	1	1	1	0	2	N/A	N/A	N/A	9	10	N/A	N/A	N/A	N/A	N/A	N/A	N/A			
A6	2004	2011	✓	✓	x	CAN	1	1	0	1	1	1	1	0	2	N/A	N/A	N/A	9	10	N/A	N/A	N/A	N/A	N/A	N/A	N/A			
A8	1994	2002	✓	✓	x	IR	0	0	0	0	1	0	1	1	1	N/A	N/A	N/A	Together	2	N/A	N/A	N/A	N/A	N/A	N/A	N/A			
TT	2003	2006	✓	✓	x	Analogue	1	1	0	1	1	1	1	0	1	32	27	N/A	Together	N/A	N/A	N/A	N/A	N/A	N/A	N/A	N/A			
TT	2006	2014	✓	✓	x	CAN	1	1	0	1	1	1	1	0	2	N/A	N/A	N/A	9	10	N/A	N/A	N/A	N/A	N/A	N/A	N/A			
TT	1999	2006	✓	✓	x	IR	0	0	0	0	1	0	1	1	1	N/A	N/A	N/A	Together	2	N/A	N/A	N/A	N/A	N/A	N/A	N/A			
TT	2006	2014	✓	✓	x	CAN	1	1	0	1	1	1	1	0	2	N/A	N/A	N/A	9	10	N/A	N/A	N/A	N/A	N/A	N/A	N/A			
TT	2006	2014	✓	✓	x	CAN	1	1	0	1	1	1	1	0	2	N/A	N/A	N/A	9	10	N/A	N/A	N/A	N/A	N/A	N/A	N/A			
1-Series	2004	2013	✓	✓	x	CAN	1	1	0	1	0	1	1	0	2	N/A	N/A	N/A	9	10	N/A	N/A	N/A	N/A	N/A	N/A	N/A			
3-Series	1998	2005	✓	✓	x	iBus*	1	0	1	1	0	1	1	0	6	N/A	N/A	N/A	N/A	N/A	S12V*	N/A	N/A	N/A	N/A	N/A	N/A			
3-Series	2006	2013	✓	✓	x	CAN	1	1	0	1	0	1	1	0	2	N/A	N/A	N/A	11	9	N/A	N/A	N/A	N/A	N/A	N/A				
5-Series	1996	2000	✓	✓	x	iBus*	1	0	1	1	0	1	1	0	6	N/A	N/A	N/A	N/A	N/A	S12V*	N/A	N/A	N/A	N/A	N/A				
5-Series	2004	2010	✓	✓	x	CAN	1	1	0	1	0	1	1	0	2	N/A	N/A	N/A	11	9	N/A	N/A	N/A	N/A	N/A	N/A				
6-Series	2003	2010	✓	✓	x	CAN	1	1	0	1	0	1	1	0	2	N/A	N/A	N/A	11	9	N/A	N/A	N/A	N/A	N/A	N/A				
6-Series	2003	2010	✓	✓	x	CAN	1	1	0	1	0	1	1	0	2	N/A	N/A	N/A	11	9	N/A	N/A	N/A	N/A	N/A	N/A				
6-Series	2003	2010	✓	✓	x	CAN	1	1	0	1	0	1	1	0	7	N/A	N/A	N/A	19	20	N/A	N/A	N/A	N/A	N/A	N/A				
7-Series	1994	2001	✓	✓	x	iBus*	1	0	1	1	0	1	1	0	6	N/A	N/A	N/A	N/A	N/A	S12V*	N/A	N/A	N/A	N/A	N/A				
7-Series	2001	2008	✓	✓	x	CAN	1	1	0	1	0	1	1	0	2	N/A	N/A	N/A	11	9	N/A	N/A	N/A	N/A	N/A	N/A				
Mfini	2001	2006	✓	✓	x	iBus*	1	0	1	0	1	1	1	0	2	N/A	N/A	N/A	N/A	N/A	S12V*	N/A	N/A	N/A	N/A	N/A				
Mfini	2001	2006	✓	✓	x	iBus*	1	0	1	0	1	1	1	0	6	N/A	N/A	N/A	N/A	N/A	S12V*	N/A	N/A	N/A	N/A	N/A				
Mfini	2006	2013	✓	✓	x	CAN	1	1	0	1	0	1	1	0	2	N/A	N/A	N/A	11	9	N/A	N/A	N/A	N/A	N/A	N/A				
Mfini	2001	2006	✓	✓	x	iBus*	1	0	1	0	1	1	1	0	2	N/A	N/A	N/A	Together	16	N/A	N/A	N/A	N/A	N/A	N/A				
Mfini	2006	2013	✓	✓	x	CAN	1	1	0	1	0	1	1	0	2	N/A	N/A	N/A	11	9	N/A	N/A	N/A	N/A	N/A	N/A				
Mfini	2001	2006	x	✓	x	iBus*	1	0	1	0	1	1	1	0	2	N/A	N/A	N/A	N/A	N/A	S12V*	N/A	N/A	N/A	N/A	N/A				
Mfini	2006	2013	✓	✓	x	CAN	1	1	0	1	0	1	1	0	7	N/A	N/A	N/A	19	20	N/A	N/A	N/A	N/A	N/A	N/A				
X3	2004	2010	✓	✓	x	iBus*	1	0	1	1	0	1	1	0	2	N/A	N/A	N/A	N/A	N/A	S12V*	N/A	N/A	N/A	N/A	N/A				
X3	2004	2010	✓	✓	x	iBus*	1	0	1	1	0	1	1	0	2	N/A	N/A	N/A	N/A	N/A	S12V*	N/A	N/A	N/A	N/A	N/A				
X3	2004	2010	✓	✓	x	iBus*	1	0	1	1	0	1	1	0	2	N/A	N/A	N/A	Together	16	N/A	N/A	N/A	N/A	N/A	N/A				

Man.	Model	Year From	Year To	Phone Button Support	Voice Assistant Support	Menu	Platform	Dipswitch Setting (0 - Off / 1 - On)								Diagram No.	IN6	IN7	Ana. GND	IN2	IN3	IN5	IN1	IN4	IN8	IN9	IN13	IN14	IN15	IN10			
								1	2	3	4	5	6	7	8																		
BMW	X3	2004	2010	✓	✓	x	iBus*	1	0	1	1	0	1	1	0	2	N/A	N/A	N/A	Together	16	N/A	9	N/A	N/A	N/A	N/A	N/A	N/A				
	X5	2000	2006	✓	✓	x	iBus*	1	0	1	1	0	1	1	0	2	N/A	N/A	N/A	N/A	S12V*	N/A	9	N/A	N/A	N/A	N/A	N/A	N/A				
	X5	2000	2001	✓	✓	x	iBus*	1	0	1	1	0	1	1	0	6	N/A	N/A	N/A	Together	N/A	14	N/A	N/A	N/A	N/A	N/A	N/A	N/A				
	X6	2000	2006	✓	✓	x	iBus*	1	0	1	1	0	1	1	0	2	N/A	N/A	N/A	Together	16	9	N/A	N/A	N/A	N/A	N/A	N/A	N/A	N/A			
	Z4	2002	2008	✓	✓	x	iBus*	1	0	1	1	0	1	1	0	2	N/A	N/A	N/A	N/A	S12V*	N/A	9	N/A	N/A	N/A	N/A	N/A	N/A	N/A	N/A		
	Z4	2009	>	✓	✓	x	CAN	1	1	0	1	0	1	1	0	2	N/A	N/A	N/A	11	9	N/A	N/A	N/A	N/A	N/A	N/A	N/A	N/A	N/A			
	Z5	2002	2008	✓	✓	x	iBus*	1	0	1	1	0	1	1	0	2	N/A	N/A	N/A	N/A	S12V*	N/A	9	N/A	N/A	N/A	N/A	N/A	N/A	N/A	N/A		
	Z5	2009	>	✓	✓	x	CAN	1	1	0	1	0	1	1	0	2	N/A	N/A	N/A	11	9	N/A	N/A	N/A	N/A	N/A	N/A	N/A	N/A	N/A	N/A		
	Z6	2002	2008	✓	✓	x	iBus*	1	0	1	1	0	1	1	0	2	N/A	N/A	N/A	Together	16	9	N/A	N/A	N/A	N/A	N/A	N/A	N/A	N/A	N/A		
	Z6	2009	>	✓	✓	x	CAN	1	1	0	1	0	1	1	0	7	N/A	N/A	N/A	19	20	N/A	N/A	N/A	N/A	N/A	N/A	N/A	N/A	N/A	N/A		
	Allure	2005	2012	✓	✓	x	Class II	1	1	1	0	0	0	1	1	8	N/A	N/A	N/A	Together	N/A	N/A	A13	N/A	N/A	N/A	N/A	N/A	N/A	N/A	N/A		
	Enclave	2008	2016	x	✓	x	CAN (SW)	1	1	1	0	1	0	0	1	8	N/A	N/A	N/A	Together	N/A	N/A	A13	N/A	N/A	N/A	N/A	N/A	N/A	N/A	N/A		
	Enclave	2008	2012	x	✓	x	CAN (SW)	1	1	1	0	1	0	0	1	8	N/A	N/A	N/A	Together	N/A	N/A	A9,A13,C21,C22	N/A	N/A	N/A	N/A	N/A	N/A	N/A	N/A	N/A	
	Lacrosse	2005	2013	✓	✓	x	Class II	1	1	1	0	1	0	0	1	8	N/A	N/A	N/A	Together	N/A	N/A	C1,C2	N/A	N/A	N/A	N/A	N/A	N/A	N/A	N/A	N/A	
	Lucerne	2006	2010	x	✓	x	CAN (SW)	1	1	1	0	1	0	0	1	8	N/A	N/A	N/A	Together	N/A	N/A	A9,A13,C21,C22	N/A	N/A	N/A	N/A	N/A	N/A	N/A	N/A	N/A	
	Rainier	2004	2007	✓	✓	x	Class II	1	1	1	0	1	0	0	1	8	N/A	N/A	N/A	Together	N/A	N/A	C1,C2	N/A	N/A	N/A	N/A	N/A	N/A	N/A	N/A	N/A	
	Regal	2011	2013	✓	✓	x	CAN (SW)	0	0	0	0	0	0	1	1	9	N/A	N/A	N/A	Together	N/A	N/A	28	N/A	N/A	N/A	N/A	N/A	N/A	N/A	N/A	N/A	
	Regal	1994	2004	✓	✓	x	Class II	1	1	1	0	0	0	1	1	8	N/A	N/A	N/A	Together	N/A	N/A	A13	N/A	N/A	N/A	N/A	N/A	N/A	N/A	N/A	N/A	
	Rendezvous	2002	2007	✓	✓	x	Class II	1	1	1	0	1	0	0	1	8	N/A	N/A	N/A	Together	N/A	N/A	C1,C2	N/A	N/A	N/A	N/A	N/A	N/A	N/A	N/A	N/A	
	Terraza	2005	2007	✓	✓	x	Class II	1	1	1	0	0	0	1	1	8	N/A	N/A	N/A	Together	N/A	N/A	C1,C2	N/A	N/A	N/A	N/A	N/A	N/A	N/A	N/A	N/A	
	Verano	2013	2013	✓	✓	x	CAN (SW)	0	0	0	1	0	0	1	1	9	N/A	N/A	N/A	Together	N/A	N/A	28	N/A	N/A	N/A	N/A	N/A	N/A	N/A	N/A	N/A	
	CTS	2003	2014	✓	✓	x	CAN (SW)	0	1	1	0	1	0	1	1	1	27	N/A	N/A	31	N/A	N/A	N/A	Together	1	N/A	N/A	N/A	N/A	N/A	N/A	N/A	21
	DTS	2006	2011	✓	✓	x	Analogue	0	1	1	0	1	0	1	0	3	N/A	N/A	N/A	Together	N/A	N/A	A13	N/A	N/A	N/A	N/A	N/A	N/A	N/A	N/A	N/A	
	Escalade	2003	2006	✓	✓	x	Class II	1	1	1	0	1	0	0	1	8	N/A	N/A	N/A	Together	N/A	N/A	C1,C2	N/A	N/A	N/A	N/A	N/A	N/A	N/A	N/A	N/A	
	SRX	2004	2009	✓	✓	x	CAN	0	0	0	1	0	1	0	1	8	N/A	N/A	N/A	A13	A14	N/A	N/A	N/A	N/A	N/A	N/A	N/A	N/A	N/A	N/A	N/A	
STS	2005	2011	✓	✓	x	CAN (SW)	1	1	1	0	1	0	0	1	?	N/A	N/A	N/A	Together	N/A	N/A	A13	N/A	N/A	N/A	N/A	N/A	N/A	N/A	N/A	N/A		
XLR	2004	2009	x	✓	x	CAN (SW)	1	1	1	0	0	0	1	1	8	N/A	N/A	N/A	Together	N/A	N/A	A13	N/A	N/A	N/A	N/A	N/A	N/A	N/A	N/A	N/A		
Astra	1998	2011	x	✓	x	Analogue	0	1	0	1	1	1	0	0	3	1	N/A	N/A	7	N/A	N/A	S12V*	N/A	N/A	N/A	N/A	N/A	N/A	N/A	N/A	N/A		
Astra	1998	2011	x	✓	x	Analogue	0	1	0	1	1	1	0	0	3	1	N/A	N/A	7	N/A	N/A	S12V*	N/A	N/A	N/A	N/A	N/A	N/A	N/A	N/A	N/A		
Avalanche	2002	2006	✓	✓	x	Class II	1	1	1	0	0	0	1	1	9	N/A	N/A	N/A	Together	N/A	N/A	N/A	N/A	N/A	N/A	N/A	N/A	N/A	N/A	N/A	N/A		
Avalanche	2007	2013	x	✓	x	CAN (SW)	1	1	1	0	0	0	1	1	8	N/A	N/A	N/A	Together	N/A	N/A	N/A	N/A	N/A	N/A	N/A	N/A	N/A	N/A	N/A	N/A		
Aveo	2002	2011	✓	✓	x	Analogue	0	0	1	1	0	1	1	0	8	N/A	N/A	N/A	A12	N/A	N/A	N/A	N/A	N/A	N/A	N/A	N/A	N/A	N/A	N/A	N/A		
Aveo	2011	>	x	✓	x	CAN (SW)	0	0	0	0	1	1	0	1	9	N/A	N/A	N/A	Together	N/A	N/A	B16	N/A	N/A	N/A	N/A	N/A	N/A	N/A	N/A	N/A		
Blazer S-10	2003	2005	✓	✓	x	Class II	1	1	0	0	0	1	1	8	N/A	N/A	N/A	Together	N/A	N/A	N/A	N/A	N/A	N/A	N/A	N/A	N/A	N/A	N/A	N/A	N/A		
Camaro	2010	2015	✓	✓	x	CAN (SW)	0	0	0	0	1	1	1	9	N/A	N/A	N/A	Together	N/A	N/A	N/A	N/A	N/A	N/A	N/A	N/A	N/A	N/A	N/A	N/A	N/A		
Captiva	2006	2011	✓	✓	x	Analogue	0	1	1	0	1	1	0	8	N/A	N/A	N/A	B12	N/A	N/A	N/A	N/A	N/A	N/A	N/A	N/A	N/A	N/A	N/A	N/A	N/A		
Captiva	2011	>	x	✓	x	CAN (SW)	1	1	1	0	1	0	0	1	8	N/A	N/A	N/A	Together	N/A	N/A	N/A	N/A	N/A	N/A	N/A	N/A	N/A	N/A	N/A	N/A		
Cavalier	2000	2005	✓	✓	x	Class II	1	1	1	0	0	0	1	1	8	N/A	N/A	N/A	Together	N/A	N/A	N/A	N/A	N/A	N/A	N/A	N/A	N/A	N/A	N/A	N/A		
Celta	2002	2010	x	✓	x	Analogue	0	1	0	1	1	1	0	3	1	N/A	N/A	7	N/A	N/A	S12V*	N/A	N/A	N/A	N/A	N/A	N/A	N/A	N/A	N/A			
Celta	2002	2010	x	✓	x	Analogue	0	1	0	1	1	1	0	3	1	N/A	N/A	7	N/A	N/A	S12V*	N/A	N/A	N/A	N/A	N/A	N/A	N/A	N/A	N/A			
Cobalt	2005	2010	x	✓	x	CAN (SW)	1	1	1	0	1	0	1	8	N/A	N/A	N/A	Together	N/A	N/A	N/A	N/A	N/A	N/A	N/A	N/A	N/A	N/A	N/A	N/A	N/A		
Colorado	2012	2014	✓	✓	x	Analogue	1	1	0	1	0	1	0	13	5	N/A	N/A	13	N/A	N/A	4	N/A	N/A	N/A	N/A	N/A	N/A	N/A	N/A	N/A			
Colorado	2012	2014	✓	✓	x	Analogue	1	1	0	1	0	1	0	13	5	N/A	N/A	13	N/A	N/A	4	N/A	N/A	N/A	N/A	N/A	N/A	N/A	N/A	N/A			
Colorado	2004	2012	✓	✓	x	Class II	1	1	1	0	0	0	1	1	8	N/A	N/A	N/A	Together	N/A	N/A	N/A	N/A	N/A	N/A	N/A	N/A	N/A	N/A	N/A	N/A		
Corssa Classic	2002	2010	x	✓	x	Analogue	0	1	0	1	1	1	0	3	1	N/A	N/A	7	N/A	N/A	S12V*	N/A	N/A	N/A	N/A	N/A	N/A	N/A	N/A	N/A			
Corssa Classic	2002	2010	x	✓	x	Analogue	0	1	0	1	1	1	0	3	1	N/A	N/A	7	N/A	N/A	S12V*	N/A	N/A	N/A	N/A	N/A	N/A	N/A	N/A	N/A			
Corvette	2007	2013	✓	✓	x	Class II	1	1	1	0	0	1	1	8	N/A	N/A	N/A	Together	N/A	N/A	N/A	N/A	N/A	N/A	N/A	N/A	N/A	N/A	N/A	N/A			
Cruze	2009	2015	✓	✓	x	CAN (SW)	0	0	0	0	1	1	1	9	N/A	N/A	N/A	Together	N/A	N/A	N/A	N/A	N/A	N/A	N/A	N/A	N/A	N/A	N/A	N/A			
Cruze	2011	2014	✓	✓	x	CAN (SW)	0	0	0	0	1	1	1	9	N/A	N/A	N/A	Together	N/A	N/A	N/A	N/A	N/A	N/A	N/A	N/A	N/A	N/A	N/A	N/A			
Equinox	2009	2016	x	✓	x	CAN (SW)	0	0	0	0	0	1	1	9	N/A	N/A	N/A	Together	N/A	N/A	N/A	N/A	N/A	N/A	N/A	N/A	N/A	N/A	N/A	N/A			
Equinox	2007	2009	x	✓	x	CAN (SW)	1	1	1	0	1	0	0	1	8	N/A	N/A	N/A	Together	N/A	N/A	N/A	N/A	N/A	N/A	N/A	N/A	N/A	N/A	N/A	N/A		
Equinox	2007	2013	x	✓	x	CAN (SW)	1	1	1	0	1	0	0	1	8	N/A	N/A	N/A	Together	N/A	N/A	A13	N/A	N/A	N/A	N/A	N/A	N/A	N/A	N/A	N/A		
Express Van	2003	2007	✓	✓	x	Class II	1	1	1	0	0	0	1	8	N/A	N/A																	

Man.	Model	Year From	Year To	Phone Button Support	Voice Assistant Support	Menu	Platform	Dipswitch Setting (0 - Off / 1 - On)								Diagram No.	IN6	IN7	Ana. GND	IN2	IN3	IN5	IN1	IN4	IN8	IN9	IN13	IN14	IN15	IN10
								1	2	3	4	5	6	7	8															
Chevrolet	Monte Carlo S-10	2006	2007	x	x	x	CAN (SW)	1	1	1	0	1	0	0	1	8	N/A	N/A	N/A	Together	N/A	N/A	N/A	N/A	N/A	N/A	N/A	N/A	N/A	
	Silverado Pickup	2012	>	✓	x	x	Analogue Class II	1	1	0	0	1	0	1	0	13	N/A	N/A	13	N/A	N/A	4	N/A	N/A	N/A	N/A	N/A	N/A	N/A	
	Silverado Pickup	2007	2006	✓	✓	x	CAN (SW)	1	1	1	0	0	1	1	1	8	N/A	N/A	N/A	Together	N/A	N/A	N/A	N/A	N/A	N/A	N/A	N/A	N/A	
	Silverado Pickup	2007	2013	x	x	x	CAN (SW)	1	1	1	0	0	0	1	1	8	N/A	N/A	N/A	Together	N/A	N/A	N/A	N/A	N/A	N/A	N/A	N/A	N/A	
	Sonic	2007	2013	x	✓	x	CAN (SW)	1	1	1	0	1	0	0	1	8	N/A	N/A	N/A	Together	N/A	N/A	16	N/A	N/A	N/A	N/A	N/A	N/A	
	Spark	2010	2015	>	✓	x	Analogue	0	0	1	1	0	1	1	0	11	N/A	N/A	13	N/A	N/A	4	N/A	N/A	N/A	N/A	N/A	N/A	N/A	
	Suburban	2007	2013	x	x	x	CAN (SW)	1	1	1	0	1	0	1	1	8	N/A	N/A	N/A	Together	N/A	N/A	N/A	N/A	N/A	N/A	N/A	N/A	N/A	
	Suburban	2003	2006	✓	✓	x	Class II	1	1	1	0	0	0	1	1	8	N/A	N/A	N/A	Together	N/A	N/A	N/A	N/A	N/A	N/A	N/A	N/A	N/A	
	Suburban	2007	2014	x	x	x	CAN (SW)	1	1	1	0	1	0	0	1	8	N/A	N/A	N/A	Together	N/A	N/A	N/A	N/A	N/A	N/A	N/A	N/A	N/A	
	Suburban	2006	2014	x	x	x	CAN (SW)	1	1	1	0	1	0	0	1	8	N/A	N/A	N/A	Together	N/A	N/A	N/A	N/A	N/A	N/A	N/A	N/A	N/A	
	Tahoe	2007	2013	x	x	x	CAN (SW)	1	1	1	0	1	0	0	1	8	N/A	N/A	N/A	Together	N/A	N/A	N/A	N/A	N/A	N/A	N/A	N/A	N/A	
	Tahoe	2003	2006	✓	✓	x	Class II	1	1	1	0	0	1	1	1	8	N/A	N/A	N/A	Together	N/A	N/A	N/A	N/A	N/A	N/A	N/A	N/A	N/A	
	Tahoe	2007	2013	x	x	x	CAN (SW)	1	1	1	0	1	0	0	1	8	N/A	N/A	N/A	Together	N/A	N/A	N/A	N/A	N/A	N/A	N/A	N/A	N/A	
	Tahoe	2007	2014	x	x	x	CAN (SW)	1	1	1	0	1	0	0	1	8	N/A	N/A	N/A	Together	N/A	N/A	N/A	N/A	N/A	N/A	N/A	N/A	N/A	
	Tracker	2009	<	2009	✓	✓	Analogue	1	0	0	1	0	1	1	0	10	N/A	N/A	20	Together	N/A	N/A	9	N/A	N/A	N/A	N/A	N/A	N/A	
	Trailblazer	2002	2009	✓	✓	x	Class II	1	1	1	0	0	1	1	1	8	N/A	N/A	N/A	Together	N/A	N/A	N/A	N/A	N/A	N/A	N/A	N/A	N/A	
	Traverse	2008	>	2008	x	x	CAN (SW)	1	1	1	0	1	0	1	1	8	N/A	N/A	N/A	Together	N/A	N/A	N/A	N/A	N/A	N/A	N/A	N/A	N/A	
	Traverse	2009	2012	x	x	x	CAN (SW)	1	1	1	0	1	0	0	1	8	N/A	N/A	N/A	Together	N/A	N/A	N/A	N/A	N/A	N/A	N/A	N/A	N/A	
	Traverse	2009	2014	x	x	x	CAN (SW)	1	1	1	0	1	0	0	1	8	N/A	N/A	N/A	Together	N/A	N/A	N/A	N/A	N/A	N/A	N/A	N/A	N/A	
	Traverse	2009	2014	x	x	x	CAN (SW)	1	1	1	0	1	0	0	1	8	N/A	N/A	N/A	Together	N/A	N/A	N/A	N/A	N/A	N/A	N/A	N/A	N/A	
	Trax	2015	2017	✓	✓	x	CAN (SW)	0	0	0	0	1	1	1	1	9	N/A	N/A	N/A	Together	N/A	N/A	N/A	N/A	N/A	N/A	N/A	N/A	N/A	
	Uplander	2005	2008	✓	✓	x	Class II	1	1	1	0	0	1	1	1	8	N/A	N/A	N/A	Together	N/A	N/A	N/A	N/A	N/A	N/A	N/A	N/A	N/A	
	Urban	1998	2011	x	x	x	Analogue	0	0	1	0	1	1	1	0	3	1	N/A	7	N/A	N/A	S12V*	N/A	N/A	N/A	N/A	N/A	N/A	N/A	
	Urban	1998	2011	x	x	x	Analogue	0	0	1	0	1	1	1	0	3	1	N/A	7	N/A	N/A	S12V*	N/A	N/A	N/A	N/A	N/A	N/A	N/A	
	Urban	2005	2011	x	x	x	Analogue	0	0	1	0	1	1	1	0	3	1	N/A	7	N/A	N/A	S12V*	N/A	N/A	N/A	N/A	N/A	N/A	N/A	
	Vectra	2005	>	2005	x	x	Analogue	0	0	1	0	1	1	1	0	3	1	N/A	7	N/A	N/A	S12V*	N/A	N/A	N/A	N/A	N/A	N/A	N/A	
	Venture	2002	2005	✓	✓	x	Class II	1	1	1	0	0	1	1	1	8	N/A	N/A	N/A	Together	N/A	N/A	N/A	N/A	N/A	N/A	N/A	N/A	N/A	
	Viva	1998	2011	x	x	x	Analogue	0	0	1	0	1	1	1	0	3	1	N/A	7	N/A	N/A	S12V*	N/A	N/A	N/A	N/A	N/A	N/A	N/A	
Viva	1998	2011	x	x	x	Analogue	0	0	1	0	1	1	1	0	3	1	N/A	7	N/A	N/A	S12V*	N/A	N/A	N/A	N/A	N/A	N/A	N/A		
300/300C	2005	2014	x	x	x	CAN	0	0	1	0	1	0	1	1	14	N/A	N/A	N/A	A21	A10	A10	N/A	N/A	N/A	N/A	N/A	N/A	N/A		
300M	1999	2004	x	x	x	CAN	0	0	0	1	0	1	0	1	14	N/A	N/A	N/A	A21	A10	A10	N/A	N/A	N/A	N/A	N/A	N/A	N/A		
Aspen	2007	2008	✓	✓	x	CAN	1	1	0	0	1	1	0	1	14	N/A	N/A	N/A	B6	B7	B7	N/A	N/A	N/A	N/A	N/A	N/A	N/A		
Concorde	2002	2004	✓	✓	x	CAN	1	1	0	0	1	1	0	1	14	N/A	N/A	N/A	B6	B7	B7	N/A	N/A	N/A	N/A	N/A	N/A	N/A		
Delta	2011	2014	✓	✓	x	CAN	0	1	1	0	1	1	1	0	1	N/A	N/A	N/A	5	6	6	N/A	N/A	N/A	N/A	N/A	N/A	N/A		
Pacifica	2004	2008	✓	✓	x	CAN	1	1	0	0	1	1	1	0	14	N/A	N/A	N/A	B6	B7	B7	N/A	N/A	N/A	N/A	N/A	N/A	N/A		
Sebring	2002	2010	✓	✓	x	CAN	1	1	0	0	1	1	0	1	14	N/A	N/A	N/A	B6	B7	B7	N/A	N/A	N/A	N/A	N/A	N/A	N/A		
Town and Country	2002	2008	✓	✓	x	CAN	1	1	0	0	1	1	0	1	14	N/A	N/A	N/A	B6	B7	B7	N/A	N/A	N/A	N/A	N/A	N/A	N/A		
Town and Country	?	?	✓	✓	x	CAN	1	1	0	0	1	1	0	1	14	N/A	N/A	N/A	B6	B7	B7	N/A	N/A	N/A	N/A	N/A	N/A	N/A		
Voyager	2001	2013	✓	✓	x	CAN	1	1	0	0	1	1	0	1	14	N/A	N/A	N/A	B6	B7	B7	N/A	N/A	N/A	N/A	N/A	N/A	N/A		
Berlingo	2008	>	2008	x	x	1*	CAN	0	1	0	0	1	1	0	2	N/A	N/A	N/A	10	13	N/A	N/A	N/A	N/A	N/A	N/A	N/A	N/A		
C1	2014	>	2014	✓	✓	x	Analogue	1	1	0	1	0	1	0	17	B20	B19	B21	Together	Together	A2	N/A	N/A	N/A	N/A	N/A	N/A	N/A		
C10	2005	2014	x	x	✓	CAN	0	1	0	0	1	1	1	0	2	N/A	N/A	N/A	10	13	N/A	N/A	N/A	N/A	N/A	N/A	N/A	N/A		
C2	2005	2009	x	x	1*	CAN	0	1	0	0	1	1	1	0	2	N/A	N/A	N/A	10	13	N/A	N/A	N/A	N/A	N/A	N/A	N/A	N/A		
C3	2005	2016	x	x	1*	CAN	0	1	0	0	1	1	1	0	2	N/A	N/A	N/A	10	13	N/A	N/A	N/A	N/A	N/A	N/A	N/A	N/A		
C3	2005	2009	x	x	x	CAN	1	1	1	0	1	0	1	1	2	N/A	N/A	N/A	10	13	N/A	N/A	N/A	N/A	N/A	N/A	N/A	N/A		
C3 Picasso	2009	>	2009	x	x	1*	CAN	0	1	0	0	1	1	1	0	2	N/A	N/A	N/A	10	13	N/A	N/A	N/A	N/A	N/A	N/A	N/A		
C4	2004	2010	x	x	1*	CAN	0	0	0	1	1	1	0	0	2	N/A	N/A	N/A	10	13	N/A	N/A	N/A	N/A	N/A	N/A	N/A	N/A		
C4	2005	2016	x	x	x	CAN	1	1	1	0	1	0	1	1	2	N/A	N/A	N/A	10	13	N/A	N/A	N/A	N/A	N/A	N/A	N/A	N/A		
C4	2005	2009	x	x	✓	CAN	0	1	0	0	1	1	1	0	2	N/A	N/A	N/A	10	13	N/A	N/A	N/A	N/A	N/A	N/A	N/A	N/A		
C4 Aircross	2014	>	2014	✓	✓	x	Analogue	0	1	0	1	0	1	0	16	A9	N/A	TC	TC	Together	A10	N/A	N/A	N/A	N/A	N/A	N/A	N/A		
C4 Aircross	2014	>	2014	✓	✓	x	Analogue	0	1	0	1	0	1	0	16	A9	N/A	TC	TC	Together	A10	N/A	N/A	N/A	N/A	N/A	N/A	N/A		
C4 Picasso	2006	>	2006	x	x	1*	CAN	0	1	0	0	1	1	0	2	N/A	N/A	N/A	10	13	N/A	N/A	N/A	N/A	N/A	N/A	N/A	N/A		
C5	2005	2008	x	x	1*	CAN	0	1	0	0	1	1	1	0	2	N/A	N/A	N/A	10	13	N/A	N/A	N/A	N/A	N/A	N/A	N/A	N/A		
C5	2004	2010	x	x	x	CAN	1	1	1	0	1	0	1	1	2	N/A	N/A	N/A	10	13	N/A	N/A	N/A	N/A	N/A	N/A	N/A	N/A		
C5	2005	2016	x	x	✓	CAN	0	1	0	0	1	1	1	0	2	N/A	N/A	N/A	10	13	N/A	N/A	N/A	N/A	N/A	N/A	N/A	N/A		
C6	2005	2008	x	x																										

Man.	Model	Year From	Year To	Phone Button Support	Voice Assistant Support	Menu	Platform	Dipswitch Setting (0 - Off / 1 - On)								Diagram No.	IN6	IN7	Ana. GND	IN2	IN3	IN5	IN1	IN4	IN8	IN9	IN13	IN14	IN15	IN10
								1	2	3	4	5	6	7	8															
Ford	C-Max	2010	>	x	x	x	CAN/Analogue	0	0	1	0	0	1	1	0	19	A7 cut	N/A	A9/A11	A4	A5	S12V*	N/A	N/A	N/A	N/A	N/A	N/A	N/A	
	Ecosport	2013	>	x	x	x	CAN/Analogue	0	0	1	0	0	1	1	0	19	A7 cut	N/A	A9/A11	A4	A5	S12V*	N/A	N/A	N/A	N/A	N/A	N/A	N/A	
	Edge	2007	2010	x	x	x	CAN/Analogue	0	0	0	1	1	0	0	1	35	A18	*PM	A19	B15	B16	N/A	N/A	N/A	N/A	N/A	N/A	N/A	N/A	
	Escape	2013	>	x	x	x	Analogue	0	0	1	0	1	0	1	0	19	A7 cut	N/A	A9/A11	A4	A5	S12V*	N/A	N/A	N/A	N/A	N/A	N/A	N/A	
	Escape	2008	2012	x	x	x	CAN/Analogue	0	0	0	1	1	0	0	1	35	A18	*PM	A19	B15	B16	N/A	N/A	N/A	N/A	N/A	N/A	N/A	N/A	
	Everest	2016	>	x	x	✓	CAN	0	0	0	1	1	0	1	1	34	A18	*PM	A19	B15	B16	N/A	N/A	N/A	N/A	N/A	N/A	N/A	N/A	
	Expedition	2007	2014	x	x	x	CAN/Analogue	0	0	0	1	1	0	1	0	35	A18	*PM	A19	B15	B16	N/A	N/A	N/A	N/A	N/A	N/A	N/A	N/A	
	Explorer	2006	2010	x	x	x	CAN/Analogue	0	0	0	1	1	0	1	0	35	A18	*PM	A19	B15	B16	N/A	N/A	N/A	N/A	N/A	N/A	N/A	N/A	
	Explorer Sport Trac	2007	2010	x	x	x	CAN/Analogue	0	0	1	1	0	1	0	1	35	A18	*PM	A19	B15	B16	N/A	N/A	N/A	N/A	N/A	N/A	N/A	N/A	
	F-150	2004	2008	x	x	x	Analogue	0	0	1	0	0	1	1	0	28	18	N/A	19	Together	Together	B6	N/A	N/A	N/A	N/A	N/A	N/A	N/A	
	F250	2005	2016	x	x	x	CAN/Analogue	0	0	1	0	1	0	1	0	35	A18	*PM	A19	B15	B16	N/A	N/A	N/A	N/A	N/A	N/A	N/A	N/A	
	F350	2005	2016	x	x	x	CAN/Analogue	0	0	1	1	0	0	1	0	35	A18	*PM	A19	B15	B16	N/A	N/A	N/A	N/A	N/A	N/A	N/A	N/A	
	F450	2005	2016	x	x	x	CAN/Analogue	0	0	1	1	0	0	1	0	35	A18	*PM	A19	B15	B16	N/A	N/A	N/A	N/A	N/A	N/A	N/A	N/A	
	F550	2005	2016	x	x	x	CAN/Analogue	0	0	1	1	0	0	1	0	35	A18	*PM	A19	B15	B16	N/A	N/A	N/A	N/A	N/A	N/A	N/A	N/A	
	Fiesta	2005	2008	x	x	x	CAN/Analogue	0	1	0	1	1	1	1	0	2	22	N/A	24	9	10	N/A	N/A	N/A	N/A	N/A	N/A	N/A	N/A	
	Fiesta	2012	>	x	x	x	CAN/Analogue	0	1	0	1	1	1	1	0	19	A7 cut	N/A	A9/A11	A4	A5	S12V*	N/A	N/A	N/A	N/A	N/A	N/A	N/A	
	Fiesta	2002	2005	x	x	x	Analogue	0	1	1	0	0	0	1	0	19	A7 cut	N/A	19	Together	Together	2	N/A	N/A	N/A	N/A	N/A	N/A	N/A	
	Fiesta	2013	>	x	x	x	CAN/Analogue	0	1	0	1	1	1	1	0	28	A7 cut	N/A	A9/A11	A4	A5	S12V*	N/A	N/A	N/A	N/A	N/A	N/A	N/A	
	Fiesta (SA Models)	2003	2008	x	x	x	Analogue	0	1	1	0	0	1	0	3	1	N/A	4	Together	Together	8	N/A	N/A	N/A	N/A	N/A	N/A	N/A	N/A	
	Five Hundred	2005	2007	x	x	x	CAN/Analogue	0	0	1	1	0	0	1	0	35	A18	*PM	A19	B15	B16	N/A	N/A	N/A	N/A	N/A	N/A	N/A	N/A	
	Flex	2008	2011	x	x	x	CAN/Analogue	0	0	1	1	0	0	1	0	35	A18	*PM	A19	B15	B16	N/A	N/A	N/A	N/A	N/A	N/A	N/A	N/A	
	Focus	2011	>	x	x	x	Analogue	0	0	1	0	0	1	1	0	19	A7 cut	N/A	A9/A11	A4	A5	S12V*	N/A	N/A	N/A	N/A	N/A	N/A	N/A	
	Focus	2015	>	x	x	x	CAN	0	0	0	1	1	0	1	0	19	A7 cut	N/A	A9/A11	A4	A5	S12V*	N/A	N/A	N/A	N/A	N/A	N/A	N/A	
	Focus	2004	2011	x	x	x	Analogue	0	1	1	0	0	0	1	0	24	22	N/A	24	Together	Together	16	N/A	N/A	N/A	N/A	N/A	N/A	N/A	
	Focus	1998	2004	x	x	x	Analogue	0	1	1	0	0	1	0	24	C5	N/A	C6	Together	Together	B6	N/A	N/A	N/A	N/A	N/A	N/A	N/A	N/A	
	Focus	2005	2007	x	x	x	CAN/Analogue	0	0	1	1	0	0	1	0	35	A18	*PM	A19	B15	B16	N/A	N/A	N/A	N/A	N/A	N/A	N/A	N/A	
	Freestyle	2005	2012	x	x	x	Analogue	0	1	1	0	0	1	0	2	22	N/A	24	Together	Together	16	N/A	N/A	N/A	N/A	N/A	N/A	N/A	N/A	
	Fusion	2002	2005	x	x	x	Analogue	0	1	0	0	1	0	1	0	28	18	N/A	19	Together	Together	2	N/A	N/A	N/A	N/A	N/A	N/A	N/A	
	Fusion (SA Models)	2002	>	x	x	x	Analogue	0	1	1	0	0	1	0	3	1	N/A	4	Together	Together	8	N/A	N/A	N/A	N/A	N/A	N/A	N/A	N/A	
	Galaxy	2000	>	x	x	x	Analogue	0	1	1	0	0	1	0	24	C5	N/A	C6	Together	Together	B6	N/A	N/A	N/A	N/A	N/A	N/A	N/A	N/A	
	KA	2009	2017	✓	x	x	CAN	0	1	1	1	1	1	0	1	N/A	N/A	N/A	5	6	N/A	N/A	N/A	N/A	N/A	N/A	N/A	N/A	N/A	
	Kuga	2008	2012	x	x	x	CAN/Analogue	0	1	0	1	1	1	1	0	2	22	N/A	24	9	10	N/A	N/A	N/A	N/A	N/A	N/A	N/A	N/A	N/A
	Kuga	2012	>	x	x	x	CAN/Analogue	0	1	0	1	0	1	1	0	19	A7 cut	N/A	A9/A11	A4	A5	S12V*	N/A	N/A	N/A	N/A	N/A	N/A	N/A	
	Kuga	2008	2012	x	x	x	CAN/Analogue	0	1	1	1	1	1	1	0	19	A7 cut	N/A	A9/A11	A4	A5	S12V*	N/A	N/A	N/A	N/A	N/A	N/A	N/A	
	Mondeo	2004	2014	x	x	x	Analogue	0	1	0	1	0	0	1	0	2	22	N/A	24	Together	Together	16	N/A	N/A	N/A	N/A	N/A	N/A	N/A	N/A
	Mondeo	2000	2004	x	x	x	Analogue	0	1	1	0	0	0	1	0	24	C5	N/A	C6	Together	Together	B6	N/A	N/A	N/A	N/A	N/A	N/A	N/A	N/A
	Mondeo	2004	2014	x	x	x	CAN/Analogue	0	1	0	1	1	1	1	0	19	A7 cut	N/A	A9/A11	A4	A5	S12V*	N/A	N/A	N/A	N/A	N/A	N/A	N/A	N/A
	Mustang	2005	2014	x	x	x	CAN/Analogue	0	0	1	1	1	1	1	0	35	A18	*PM	A19	B15	B16	N/A	N/A	N/A	N/A	N/A	N/A	N/A	N/A	N/A
	Puma	1997	2002	x	x	x	Analogue	0	1	0	0	1	0	1	0	24	C5	N/A	C6	Together	Together	B6	N/A	N/A	N/A	N/A	N/A	N/A	N/A	N/A
	Ranger	2012	>	x	x	x	CAN/Analogue	0	0	1	0	0	1	1	0	19	A7 cut	N/A	A9/A11	A4	A5	S12V*	N/A	N/A	N/A	N/A	N/A	N/A	N/A	N/A
Ranger	2013	>	x	x	x	CAN/Analogue	0	0	1	1	1	1	1	0	19	A7 cut	N/A	A9/A11	A4	A5	S12V*	N/A	N/A	N/A	N/A	N/A	N/A	N/A	N/A	
Ranger	2016	>	x	x	✓	CAN/Analogue	0	0	1	1	1	1	1	0	34	A18	N/A	N/A	A14	A15	N/A	N/A	N/A	N/A	N/A	N/A	N/A	N/A	N/A	
S-Max	2006	2014	x	x	x	CAN/Analogue	0	1	0	1	1	1	1	0	2	22	N/A	24	9	10	N/A	N/A	N/A	N/A	N/A	N/A	N/A	N/A	N/A	
S-Max	2011	2016	x	x	x	CAN/Analogue	0	1	0	1	1	1	1	0	19	A7 cut	N/A	A9/A11	A4	A5	S12V*	N/A	N/A	N/A	N/A	N/A	N/A	N/A	N/A	
Taurus	2008	2012	x	x	x	CAN/Analogue	0	1	0	1	0	1	1	0	19	A7 cut	N/A	A9/A11	A4	A5	S12V*	N/A	N/A	N/A	N/A	N/A	N/A	N/A	N/A	
Taurus	2008	2013	x	x	x	CAN/Analogue	0	0	1	1	0	0	1	0	35	A18	*PM	A19	B15	B16	N/A	N/A	N/A	N/A	N/A	N/A	N/A	N/A	N/A	
Transit	2006	2013	x	x	x	CAN/Analogue	0	1	0	1	1	1	1	0	2	22	N/A	24	9	10	N/A	N/A	N/A	N/A	N/A	N/A	N/A	N/A	N/A	
Transit	2006	2013	x	x	x	Analogue	0	1	1	0	0	0	1	0	2	22	N/A	24	Together	Together	16	N/A	N/A	N/A	N/A	N/A	N/A	N/A	N/A	
Transit	<	2006	x	x	x	Analogue	0	1	1	0	0	0	1	0	24	C5	N/A	C6	Together	Together	B6	N/A	N/A	N/A	N/A	N/A	N/A	N/A	N/A	
Transit	2013	>	x	x	x	CAN/Analogue	0	1	0	1	1	1	1	0	19	A7 cut	N/A	A9/A11	A4	A5	S12V*	N/A	N/A	N/A	N/A	N/A	N/A	N/A	N/A	
Transit Connect	2013	>	x	x	x	CAN/Analogue	0	1	0	0	1	1	1	0	19	A7 cut	N/A	A9/A11	A4	A5	S12V*	N/A	N/A	N/A	N/A	N/A	N/A	N/A	N/A	
Transit Connect	2004	2013	x	x	x	CAN/Analogue	0	1	0	0	1	0	1	0	2	22	N/A	24	Together	Together	16	N/A	N/A	N/A	N/A	N/A	N/A	N/A	N/A	
Transit Custom	2012	2016	x	x	x	CAN/Analogue	0	0	1	0	0	1	1	0	19	A7 cut	N/A	A9/A11	A4	A5	S12V*	N/A	N/A	N/A	N/A	N/A	N/A	N/A	N/A	
Acadia	2007	2014	x	x	✓	CAN (SW)	1	1	1	0	1	0	0	1	8	N/A	N/A	N/A	Together	Together	N/A	N/A	N/A	N/A	N/A	N/A	N/A	N/A		
Canyon	2004	2012	✓	x	✓	Class II	1	1	1	0	1	0	0	1	8	N/A	N/A	N/A	Together	Together	N/A	N/A	N/A	N/A	N/A	N/A	N/A	N/A		
Envoy	2002	2009	✓	x	✓	Class II	1	1	1	0	1	0	0	1	8	N/A	N/A	N/A	Together	Together	N/A	N/A	N/A	N/A	N/A	N/A	N/A	N/A		
Savana	2003	2007	✓	x	✓	Class II	1	1	1	0	1	0	0	1	8	N/A	N/A	N/A	Together	Together	N/A	N/A	N/A	N/A	N/A	N/A	N/A	N/A		
Savana	2008	2015	✓	x	✓	CAN (SW)	1	1	1	0	1	0	0	1	8	N/A	N/A	N/A	Together	Together	N/A	N/A	N/A	N/A	N/A	N/A	N/A	N/A		
Sierra	2003	2006	✓	x	✓	Class II	1	1	1	0	1	0	0	1	8	N/A	N/A	N/A	Together	Together	N/A	N/A	N/A	N/A	N/A	N/A	N/A	N/A		

Man.	Model	Year From	Year To	Phone Button Support	Voice Assistant Support	Menu	Platform	Dipswitch Setting (0 - Off / 1 - On)								Diagram No.	IN6	IN7	Ana. GND	IN2	IN3	IN5	IN1	IN4	IN8	IN9	IN13	IN14	IN15	IN10	
								1	2	3	4	5	6	7	8																
GMC	Sierra	2007	2013	x	x	x	CAN (SW)	1	1	1	0	1	0	1	0	1	0	N/A	Together	N/A	A9-A13,C21,C22	N/A	N/A	N/A	N/A	N/A	N/A	N/A	N/A		
	Sonoma	2002	2004	✓	✓	x	Class II	1	1	1	0	1	0	0	1	0	1	N/A	Together	N/A	C1,C2	N/A	N/A	N/A	N/A	N/A	N/A	N/A	N/A		
	Yukon	2003	2006	✓	✓	x	Class II	1	1	1	0	1	0	0	1	0	1	N/A	Together	N/A	C1,C2	N/A	N/A	N/A	N/A	N/A	N/A	N/A	N/A	N/A	
	Yukon	2007	2014	x	x	x	CAN (SW)	1	1	1	0	1	0	0	1	0	1	N/A	Together	N/A	A9-A13,C21,C22	N/A	N/A	N/A	N/A	N/A	N/A	N/A	N/A	N/A	
	H6	2012	>	✓	✓	x	Analogue	1	0	0	0	0	1	0	0	1	0	6	1	5	2	N/A	N/A	N/A	N/A	N/A	N/A	N/A	N/A	N/A	N/A
	Steed	2011	>	x	x	x	Analogue	1	0	1	0	0	1	1	0	0	1	1	5	5	2	N/A	N/A	N/A	N/A	N/A	N/A	N/A	N/A	N/A	N/A
Great Wall	Wingle	2011	>	x	x	x	Analogue	1	0	1	0	0	1	1	0	0	1	5	5	2	N/A	N/A	N/A	N/A	N/A	N/A	N/A	N/A	N/A	N/A	
	Street Glide (FLHX-FLHT)	2015	>	✓	x	x	CAN	0	1	1	0	1	0	1	0	0	0	N/A	12	24	N/A	N/A	N/A	N/A	N/A	N/A	N/A	N/A	N/A	N/A	
Harley Davidson	Barina	2000	2005	x	x	x	Analogue	0	0	1	0	1	1	1	0	0	1	N/A	7	Together	S12V*	N/A	N/A	N/A	N/A	N/A	N/A	N/A	N/A	N/A	
	Barina	2000	2005	x	x	x	Analogue	0	0	1	0	1	1	1	0	0	1	N/A	7	Together	S12V*	N/A	N/A	N/A	N/A	N/A	N/A	N/A	N/A	N/A	
Holden	Captiva	2008	2014	✓	✓	x	Analogue	0	0	1	0	1	1	1	0	0	8	B12	A12	B16	N/A	N/A	N/A	N/A	N/A	N/A	N/A	N/A	N/A	N/A	
	Accord	2008	2017	✓	✓	x	Analogue	1	1	1	0	1	1	1	0	0	38	A21	B12	A23	N/A	N/A	N/A	N/A	N/A	N/A	N/A	N/A	N/A	N/A	
Honda	Accord	1998	2015	✓	✓	x	Analogue	1	1	0	1	1	1	1	0	0	38	A21	B12	A23	N/A	N/A	N/A	N/A	N/A	N/A	N/A	N/A	N/A	N/A	
	Amaze	2012	>	✓	✓	x	Analogue	1	1	0	1	1	1	1	0	0	37	B4	B5	A13	N/A	N/A	N/A	N/A	N/A	N/A	N/A	N/A	N/A	N/A	
Hyundai	Ballade	2011	>	✓	✓	x	Analogue	1	1	0	1	1	1	1	0	0	38	A21	B12	A23	N/A	N/A	N/A	N/A	N/A	N/A	N/A	N/A	N/A	N/A	N/A
	Brio	2012	>	✓	✓	x	Analogue	1	1	0	1	1	1	1	0	0	38	A21	B12	A23	N/A	N/A	N/A	N/A	N/A	N/A	N/A	N/A	N/A	N/A	N/A
Honda	City	2008	2013	✓	✓	x	Analogue	1	1	0	1	1	1	1	0	0	37	B4	B5	A13	N/A	N/A	N/A	N/A	N/A	N/A	N/A	N/A	N/A	N/A	N/A
	City	2014	>	✓	✓	x	Analogue	1	1	0	1	1	1	1	0	0	38	A21	B9	B23	N/A	N/A	N/A	N/A	N/A	N/A	N/A	N/A	N/A	N/A	N/A
Honda	City	2016	>	✓	✓	x	Analogue	1	1	0	1	1	1	1	0	0	38	A21	A22	A23	N/A	N/A	N/A	N/A	N/A	N/A	N/A	N/A	N/A	N/A	N/A
	City	2016	>	✓	✓	x	Analogue	1	1	0	1	1	1	1	0	0	37	B4	B5	A13	N/A	N/A	N/A	N/A	N/A	N/A	N/A	N/A	N/A	N/A	N/A
Honda	Civic	2005	2012	✓	✓	x	Analogue	1	1	0	1	1	1	1	0	0	38	B4	B5	A13	N/A	N/A	N/A	N/A	N/A	N/A	N/A	N/A	N/A	N/A	N/A
	Civic	2012	2015	✓	✓	x	CAN	1	0	1	0	0	1	0	0	0	38	N/A	N/A	N/A	N/A	N/A	N/A	N/A	N/A	N/A	N/A	N/A	N/A	N/A	N/A
Honda	Civic	2001	2005	x	x	x	Analogue	1	0	1	0	1	1	1	0	0	10	8	7	9	N/A	N/A	N/A	N/A	N/A	N/A	N/A	N/A	N/A	N/A	N/A
	Civic Sedan	2016	>	✓	✓	x	CAN/Analogue	0	0	0	0	1	0	0	1	0	39	7	18	14	N/A	N/A	N/A	N/A	N/A	N/A	N/A	N/A	N/A	N/A	N/A
Honda	Crosstour	2010	2016	✓	✓	x	Analogue	1	1	0	1	1	1	1	0	0	38	A21	B12	A23	N/A	N/A	N/A	N/A	N/A	N/A	N/A	N/A	N/A	N/A	N/A
	CR-V	2009	2012	✓	✓	x	Analogue	1	1	0	1	1	1	1	0	0	37	A21	B12	A23	N/A	N/A	N/A	N/A	N/A	N/A	N/A	N/A	N/A	N/A	N/A
Honda	CR-V	2005	2009	✓	✓	x	Analogue	1	1	0	1	1	1	1	0	0	38	B4	B5	A13	N/A	N/A	N/A	N/A	N/A	N/A	N/A	N/A	N/A	N/A	N/A
	CR-V	2005	2007	x	x	x	Analogue	1	0	1	0	1	1	1	0	0	10	8	7	9	N/A	N/A	N/A	N/A	N/A	N/A	N/A	N/A	N/A	N/A	N/A
Honda	CR-V	2017	>	✓	✓	x	CAN/Analogue	0	0	0	0	1	0	0	1	0	39	7	18	14	N/A	N/A	N/A	N/A	N/A	N/A	N/A	N/A	N/A	N/A	N/A
	CR-Z	2011	2015	✓	✓	x	Analogue	1	1	0	1	1	1	1	0	0	38	A21	B12	A23	N/A	N/A	N/A	N/A	N/A	N/A	N/A	N/A	N/A	N/A	N/A
Honda	Element	2006	2011	✓	✓	x	Analogue	1	1	0	1	1	1	1	0	0	10	8	17	9	N/A	N/A	N/A	N/A	N/A	N/A	N/A	N/A	N/A	N/A	N/A
	Fit	2007	2014	✓	✓	x	Analogue	1	1	0	1	1	1	1	0	0	38	A21	B12	A23	N/A	N/A	N/A	N/A	N/A	N/A	N/A	N/A	N/A	N/A	N/A
Honda	Fit	2014	>	✓	✓	x	Analogue	1	1	0	1	1	1	1	0	0	38	A21	B9	A23	N/A	N/A	N/A	N/A	N/A	N/A	N/A	N/A	N/A	N/A	N/A
	Fit	2016	>	✓	✓	x	Analogue	1	1	0	1	1	1	1	0	0	38	A21	B9	A23	N/A	N/A	N/A	N/A	N/A	N/A	N/A	N/A	N/A	N/A	N/A
Honda	HR-V	2014	>	✓	✓	x	Analogue	1	1	0	1	1	1	1	0	0	38	A21	B9	A23	N/A	N/A	N/A	N/A	N/A	N/A	N/A	N/A	N/A	N/A	N/A
	HR-V	2016	>	✓	✓	x	Analogue	1	1	0	1	1	1	1	0	0	38	A21	B9	A23	N/A	N/A	N/A	N/A	N/A	N/A	N/A	N/A	N/A	N/A	N/A
Honda	Insight	2010	2013	✓	✓	x	Analogue	1	1	0	1	1	1	1	0	0	38	A21	B12	A23	N/A	N/A	N/A	N/A	N/A	N/A	N/A	N/A	N/A	N/A	N/A
	Jazz	2008	2014	✓	✓	x	Analogue	1	1	0	1	1	1	1	0	0	38	A21	B12	A23	N/A	N/A	N/A	N/A	N/A	N/A	N/A	N/A	N/A	N/A	N/A
Honda	Jazz	2005	>	✓	✓	x	Analogue	1	1	0	1	1	1	1	0	0	10	8	20	9	N/A	N/A	N/A	N/A	N/A	N/A	N/A	N/A	N/A	N/A	N/A
	Odyssey	1999	2015	✓	✓	x	Analogue	1	1	0	1	1	1	1	0	0	38	B7	B6	A23	N/A	N/A	N/A	N/A	N/A	N/A	N/A	N/A	N/A	N/A	N/A
Honda	Pilot	2016	>	✓	✓	x	Analogue	1	1	0	1	1	1	1	0	0	38	A21	A22	A23	N/A	N/A	N/A	N/A	N/A	N/A	N/A	N/A	N/A	N/A	N/A
	Pilot	2003	2015	✓	✓	x	Analogue	1	1	0	1	1	1	1	0	0	38	A21	B12	A23	N/A	N/A	N/A	N/A	N/A	N/A	N/A	N/A	N/A	N/A	N/A
Honda	Ridgeline	2016	>	✓	✓	x	Analogue	1	1	0	1	1	1	1	0	0	38	A21	A22	A23	N/A	N/A	N/A	N/A	N/A	N/A	N/A	N/A	N/A	N/A	N/A
	Ridgeline	2006	2014	✓	✓	x	Analogue	1	1	0	1	1	1	1	0	0	38	A21	B12	A23	N/A	N/A	N/A	N/A	N/A	N/A	N/A	N/A	N/A	N/A	N/A
Honda	S2000	2001	2004	x	x	x	Analogue	1	0	1	0	1	1	0	0	0	10	8	7	9	N/A	N/A	N/A	N/A	N/A	N/A	N/A	N/A	N/A	N/A	
	S2000	2005	2009	✓	✓	x	Analogue	1	1	0	1	1	1	1	0	0	37	B4	B5	A13	N/A	N/A	N/A	N/A	N/A	N/A	N/A	N/A	N/A	N/A	
Honda	H2	2003	2007	✓	✓	x	Class II	1	1	1	0	0	0	1	1	0	8	N/A	N/A	N/A	N/A	N/A	N/A	N/A	N/A	N/A	N/A	N/A	N/A	N/A	
	H2	2008	2009	x	x	x	CAN (SW)	1	1	1	0	0	0	1	1	0	8	N/A	N/A	N/A	N/A	N/A	N/A	N/A	N/A	N/A	N/A	N/A	N/A	N/A	
Honda	H3	2006	2009	✓	✓	x	Class II	1	1	1	0	0	0	1	1	0	8	N/A	N/A	N/A	N/A	N/A	N/A	N/A	N/A	N/A	N/A	N/A	N/A	N/A	
	Accent	2010	2013	✓	✓	x	Analogue	0	0	0	1	0	1	0	1	0	1	19	N/A	20	2	N/A	N/A	N/A	N/A	N/A	N/A	N/A	N/A	N/A	
Honda	Azera	2011	>	✓	✓	x	Analogue	0	0	0	1	0	1	0	0	0	22	A4	A17	A11	N/A	N/A	N/A	N/A	N/A	N/A	N/A	N/A	N/A	N/A	
	Elantra	2011	>	✓	✓	x	An																								

Man.	Model	Year From	Year To	Phone Button Support	Voice Assistant Support	Menu	Platform	Dipswitch Setting (0 - Off / 1 - On)								Diagram No.	IN6	IN7	Ana. GND	IN2	IN3	IN5	IN1	IN4	IN8	IN9	IN13	IN14	IN15	IN10
								1	2	3	4	5	6	7	8															
Mahindra	Scorpio	2006	>	✓	✗	✗	Analogue	1	0	1	0	1	1	1	0	1	N/A	6	Together	7	N/A	N/A	N/A	N/A	N/A	N/A	N/A	N/A		
	2	2007	>	✗	✗	✗	Analogue	0	1	0	1	0	1	0	0	26	12	N/A	13	Together	22	N/A	N/A	N/A	N/A	N/A	N/A	N/A		
	3	2009	2013	✗	✗	✗	CAN/Analogue	0	1	0	1	1	0	1	0	26	12	N/A	13	20	21	N/A	N/A	N/A	N/A	N/A	N/A	N/A		
	3	2004	2008	✗	✗	✗	Analogue	0	1	0	1	0	1	0	0	26	12	N/A	13	Together	22	N/A	N/A	N/A	N/A	N/A	N/A	N/A		
	3	2004	2008	✗	✗	✗	Analogue	0	1	0	1	0	1	0	0	26	12	N/A	13	Together	22	N/A	N/A	N/A	N/A	N/A	N/A	N/A		
	5	2010	>	✗	✗	✗	CAN/Analogue	0	1	0	1	1	1	0	0	26	12	N/A	13	20	21	N/A	N/A	N/A	N/A	N/A	N/A	N/A		
Mazda	6	2007	2009	✗	✗	2*	CAN/Analogue	0	1	0	1	1	1	0	0	26	12	N/A	13	20	21	N/A	N/A	N/A	N/A	N/A	N/A	N/A		
	6	2010	2013	✗	✗	✗	CAN/Analogue	0	1	0	1	1	1	0	0	26	12	N/A	13	20	21	N/A	N/A	N/A	N/A	N/A	N/A	N/A		
	BT-50	2010	2013	✗	✗	✗	CAN/Analogue	0	1	0	1	1	1	0	0	26	12	N/A	A9/A11	A4	A5	S12V*	N/A	N/A	N/A	N/A	N/A	N/A		
	BT-50	2017	>	✗	✗	✗	Analogue	0	1	0	0	0	1	1	0	19	A7 cut	N/A	20	Together	S12V*	N/A	N/A	N/A	N/A	N/A	N/A			
	CX5	2013	2015	✗	✗	3*	CAN/Analogue	0	1	0	1	1	1	0	0	26	12	N/A	13	20	21	N/A	N/A	N/A	N/A	N/A	N/A			
	CX-7	2008	2012	✗	✗	✓	CAN/Analogue	0	1	0	1	1	1	0	0	26	12	N/A	13	20	21	N/A	N/A	N/A	N/A	N/A	N/A			
	CX-9	2007	2015	✗	✗	✓	CAN/Analogue	0	1	0	1	1	1	0	0	26	12	N/A	13	20	21	N/A	N/A	N/A	N/A	N/A	N/A			
	Miata (MX5)	2006	2014	✗	✗	✗	Analogue	0	1	0	1	0	1	1	0	2	N/A	13	Together	22	N/A	N/A	N/A	N/A	N/A	N/A	N/A			
	MPV/Van	2002	2006	✗	✗	✗	Analogue	0	1	0	1	0	1	1	0	26	12	N/A	13	Together	22	N/A	N/A	N/A	N/A	N/A	N/A	N/A		
	RX8	2004	2011	✗	✗	✗	Analogue	0	1	0	1	0	1	1	0	26	12	N/A	13	Together	22	N/A	N/A	N/A	N/A	N/A	N/A	N/A		
	Tribute	2008	2010	✗	✗	✗	Analogue	0	1	0	1	0	1	1	0	26	12	N/A	13	Together	22	N/A	N/A	N/A	N/A	N/A	N/A	N/A		
	A-Class	2004	2012	✓	✗	✗	CAN	1	0	1	1	1	1	0	0	2	N/A	N/A	N/A	11	9	N/A	N/A	N/A	N/A	N/A	N/A			
	A-Class	2013	>	✓	✓	✓	CAN	0	0	1	0	1	0	1	1	2	N/A	N/A	N/A	11	9	N/A	N/A	N/A	N/A	N/A	N/A			
	B-Class	2011	>	✓	✓	✓	CAN	0	0	1	0	1	0	1	1	2	N/A	N/A	N/A	11	9	N/A	N/A	N/A	N/A	N/A	N/A			
	B-Class	2005	2011	✓	✗	✗	CAN	1	0	1	1	1	1	1	0	2	N/A	N/A	N/A	11	9	N/A	N/A	N/A	N/A	N/A	N/A			
	B-Class	2005	2011	✓	✗	✗	CAN	1	0	1	1	1	1	1	0	3	N/A	N/A	N/A	3	8	N/A	N/A	N/A	N/A	N/A	N/A			
	B-Class	2005	2011	✓	✗	✗	CAN	1	0	1	1	1	1	1	0	1	N/A	N/A	N/A	17	30	N/A	N/A	N/A	N/A	N/A	N/A			
	B-Class	2004	2007	✓	✗	✗	CAN	1	0	1	1	1	1	1	0	1	N/A	N/A	N/A	11	9	N/A	N/A	N/A	N/A	N/A	N/A			
C-Class	2007	2012	✓	✓	✓	CAN	0	0	1	0	1	0	1	1	2	N/A	N/A	N/A	11	9	N/A	N/A	N/A	N/A	N/A	N/A	N/A			
C-Class	2001	2004	✗	✗	✗	CAN	0	1	0	1	0	1	0	1	47	N/A	N/A	N/A	22	17	N/A	N/A	N/A	N/A	N/A	N/A	N/A			
C-Class	2000	2004	✓	✗	✗	CAN	1	0	1	1	1	1	1	0	3	N/A	N/A	N/A	3	8	N/A	N/A	N/A	N/A	N/A	N/A	N/A			
C-Class	2012	>	✓	✓	✓	Matrix	0	0	1	0	1	0	1	1	32	A2	A4	N/A	Together	C2	N/A	N/A	N/A	A3	N/A	A8	A1	A7	N/A	
GLA	2013	>	✓	✓	✓	CAN	0	0	1	0	1	0	1	1	2	N/A	N/A	N/A	11	9	N/A	N/A	N/A	N/A	N/A	N/A	N/A			
GLA	2013	>	✓	✓	✓	CAN	0	0	1	0	1	0	1	1	2	N/A	N/A	N/A	11	9	N/A	N/A	N/A	N/A	N/A	N/A	N/A			
CLK	2001	2004	✗	✗	✗	CAN	0	1	0	1	0	1	0	1	47	N/A	N/A	N/A	22	17	N/A	N/A	N/A	N/A	N/A	N/A	N/A			
E-Class	2002	2009	✓	✗	✗	CAN	1	0	1	1	1	1	0	0	2	N/A	N/A	N/A	17	18	N/A	N/A	N/A	N/A	N/A	N/A	N/A			
E-Class	2009	2012	✓	✓	✓	CAN	0	0	1	0	1	0	1	1	2	N/A	N/A	N/A	11	9	N/A	N/A	N/A	N/A	N/A	N/A	N/A			
E-Class	2002	2009	✓	✗	✗	CAN	1	0	1	1	1	1	1	0	2	N/A	N/A	N/A	17	18	N/A	N/A	N/A	N/A	N/A	N/A	N/A			
E-Class	2007	2008	✓	✓	✓	CAN	1	0	1	1	1	1	1	0	2	N/A	N/A	N/A	9	11	N/A	N/A	N/A	N/A	N/A	N/A	N/A			
GL	2007	2008	✓	✓	✓	CAN	1	0	1	1	1	1	1	0	2	N/A	N/A	N/A	9	11	N/A	N/A	N/A	N/A	N/A	N/A	N/A			
GLA	2013	>	✓	✓	✓	CAN	0	0	1	0	1	0	1	1	2	N/A	N/A	N/A	11	9	N/A	N/A	N/A	N/A	N/A	N/A	N/A			
ML	2005	2011	✓	✗	✗	CAN	1	0	1	1	1	1	1	0	2	N/A	N/A	N/A	11	9	N/A	N/A	N/A	N/A	N/A	N/A	N/A			
ML	2005	2011	✓	✗	✗	CAN	1	0	1	1	1	1	1	0	2	N/A	N/A	N/A	11	9	N/A	N/A	N/A	N/A	N/A	N/A	N/A			
R-Class	2006	2013	✓	✗	✗	CAN	1	0	1	1	1	1	1	0	2	N/A	N/A	N/A	11	9	N/A	N/A	N/A	N/A	N/A	N/A	N/A			
S500	2000	2000	✓	✗	✗	CAN	1	0	1	1	1	1	1	0	2	N/A	N/A	N/A	17	18	N/A	N/A	N/A	N/A	N/A	N/A	N/A			
S-Class	2001	2008	✓	✗	✗	CAN	1	0	1	1	1	1	1	0	2	N/A	N/A	N/A	17	18	N/A	N/A	N/A	N/A	N/A	N/A	N/A			
SLK	2004	2011	✓	✗	✗	CAN	1	0	1	1	1	1	1	0	2	N/A	N/A	N/A	17	18	N/A	N/A	N/A	N/A	N/A	N/A	N/A			
Sprinter	2006	>	✓	✗	✗	CAN	1	0	1	1	1	1	1	0	2	N/A	N/A	N/A	11	9	N/A	N/A	N/A	N/A	N/A	N/A	N/A			
Sprinter	2006	>	✓	✗	✗	CAN	1	0	1	1	1	1	1	0	3	N/A	N/A	N/A	3	8	N/A	N/A	N/A	N/A	N/A	N/A	N/A			
Viano	2004	2015	✓	✗	✗	CAN	1	0	1	1	1	1	1	0	1	N/A	N/A	N/A	17	30	N/A	N/A	N/A	N/A	N/A	N/A	N/A			
Vito	2015	>	✓	✓	✓	CAN	0	0	1	1	1	1	1	0	2	N/A	N/A	N/A	11	9	N/A	N/A	N/A	N/A	N/A	N/A	N/A			
Vito	2004	2015	✓	✓	✓	CAN	1	0	1	1	1	1	1	0	3	N/A	N/A	N/A	3	8	N/A	N/A	N/A	N/A	N/A	N/A	N/A			
Vito	2015	>	✓	✓	✓	CAN	0	0	1	0	1	0	1	1	3	N/A	N/A	N/A	3	8	N/A	N/A	N/A	N/A	N/A	N/A	N/A			
Vito	2004	2015	✓	✓	✓	CAN	1	0	1	1	1	1	1	0	1	N/A	N/A	N/A	17	30	N/A	N/A	N/A	N/A	N/A	N/A	N/A			
Vito	2004	2015	✓	✓	✓	CAN	1	0	1	1	1	1	1	0	1	N/A	N/A	N/A	17	30	N/A	N/A	N/A	N/A	N/A	N/A	N/A			
Mariner	2008	2010	✗	✗	✗	CAN/Analogue	0	0	1	1	0	1	0	1	35	A18	A18	A19	B15	B16	N/A	N/A	N/A	N/A	N/A	N/A	N/A			
Milan	2006	2010	✗	✗	✗	CAN/Analogue	0	0	1	1	0	1	0	1	35	A18	A18	A19	B15	B16	N/A	N/A	N/A	N/A	N/A	N/A	N/A			
Montego	2005	2007	✗	✗	✗	CAN/Analogue	0	0	1	1	0	1	0	1	35	A18	A18	A19	B15	B16	N/A	N/A	N/A	N/A	N/A	N/A	N/A			
Mountaineer	2006	2010	✗	✗	✗	CAN/Analogue	0	0	1	1	0	1	0	1	35	A18	A18	A19	B15	B16	N/A	N/A	N/A	N/A	N/A	N/A	N/A			
Sable	2008	2009	✗	✗	✗	CAN/Analogue	0	0	1	1	0	1	0	1	35	A18	A18	A19	B15	B16	N/A	N/A	N/A	N/A	N/A	N/A	N/A			
ZR	2001	2005	✗	✗																										

Man.	Model	Year From	Year To	Phone Button Support	Voice Assistant Support	Menu	Platform	Dipswitch Setting (0 - Off / 1 - On)								Diagram No.	IN6	IN7	Ana. GND	IN2	IN3	IN5	IN1	IN4	IN8	IN9	IN13	IN14	IN15	IN10
								1	2	3	4	5	6	7	8															
Mitsubishi	ASX	2010	>	✓	x	x	Analogue	0	1	1	0	1	0	1	0	16	N/A	N/A	TC	Together	A10	N/A	N/A	N/A	N/A	N/A	N/A	N/A		
	ASX	2010	>	✓	x	x	Analogue	0	1	1	0	1	0	1	0	16	N/A	N/A	TC	Together	A10	N/A	N/A	N/A	N/A	N/A	N/A	N/A		
	ASX	2010	>	✓	x	x	Analogue	0	1	1	0	1	0	1	0	16	N/A	N/A	TC	Together	A10	N/A	N/A	N/A	N/A	N/A	N/A	N/A		
	Attrage	2015	>	✓	x	x	Analogue	0	1	1	0	1	0	1	0	16	N/A	N/A	TC	Together	A10	N/A	N/A	N/A	N/A	N/A	N/A	N/A		
	Attrage	2015	>	✓	x	x	Analogue	0	1	1	0	1	0	1	0	16	N/A	N/A	TC	Together	A10	N/A	N/A	N/A	N/A	N/A	N/A	N/A		
	Attrage	2015	>	✓	x	x	Analogue	0	1	1	0	1	0	1	0	16	N/A	N/A	TC	Together	A10	N/A	N/A	N/A	N/A	N/A	N/A	N/A		
	Colt	2009	2012	>	✓	x	x	Analogue	0	1	1	0	1	0	1	0	49	N/A	N/A	B3	Together	A11	N/A	B30	N/A	N/A	N/A	N/A		
	L200	2015	>	✓	x	x	Analogue	0	1	1	0	1	0	1	0	16	N/A	N/A	TC	Together	A10	N/A	N/A	N/A	N/A	N/A	N/A	N/A		
	L200	2015	>	✓	x	x	Analogue	0	1	1	0	1	0	1	0	16	N/A	N/A	TC	Together	A10	N/A	N/A	N/A	N/A	N/A	N/A	N/A		
	L200	2015	>	✓	x	x	Analogue	0	1	1	0	1	0	1	0	16	N/A	N/A	TC	Together	A10	N/A	N/A	N/A	N/A	N/A	N/A	N/A		
	L200	2012	>	✓	x	x	Analogue	0	1	1	0	1	0	1	0	51	N/A	N/A	B12	Together	A11	N/A	N/A	N/A	N/A	N/A	N/A	N/A		
	L200	2010	2012	>	✓	x	x	Analogue	0	1	1	0	1	0	1	0	49	N/A	N/A	B10	Together	A11	N/A	N/A	N/A	N/A	N/A	N/A	N/A	
	Lancer	2007	2010	>	✓	x	x	Analogue	0	1	1	0	1	0	1	0	16	N/A	N/A	TC	Together	A10	N/A	N/A	N/A	N/A	N/A	N/A	N/A	
	Lancer	2010	>	✓	x	x	✓	Analogue	0	1	1	0	1	0	1	0	16	N/A	N/A	TC	Together	A10	N/A	N/A	N/A	N/A	N/A	N/A	N/A	
	Lancer	2007	2010	>	✓	x	x	Analogue	0	1	1	0	1	0	1	0	16	N/A	N/A	TC	Together	A10	N/A	N/A	N/A	N/A	N/A	N/A	N/A	
	Mirage	2013	>	✓	x	x	x	Analogue	0	1	1	0	1	0	1	0	16	N/A	N/A	TC	Together	A10	N/A	N/A	N/A	N/A	N/A	N/A	N/A	
	Mirage	2013	>	✓	x	x	x	Analogue	0	1	1	0	1	0	1	0	16	N/A	N/A	TC	Together	A10	N/A	N/A	N/A	N/A	N/A	N/A	N/A	
	Outlander	2007	2010	>	✓	x	x	Analogue	0	1	1	0	1	0	1	0	16	N/A	N/A	TC	Together	A10	N/A	N/A	N/A	N/A	N/A	N/A	N/A	
	Outlander	2010	2013	>	✓	x	x	Analogue	0	1	1	0	1	0	1	0	16	N/A	N/A	TC	Together	A10	N/A	N/A	N/A	N/A	N/A	N/A	N/A	
	Outlander	2007	2013	>	✓	x	✓	Analogue	0	1	1	0	1	0	1	0	16	N/A	N/A	TC	Together	A10	N/A	N/A	N/A	N/A	N/A	N/A	N/A	
	Outlander	2013	2018	>	✓	x	x	CAN/Analogue	1	0	1	0	1	0	1	0	53	9	N/A	11	8	18	N/A	N/A	N/A	N/A	N/A	N/A	N/A	
	Outlander Sport	2010	>	✓	✓	x	✓	Analogue	0	1	1	0	1	0	1	0	16	N/A	N/A	TC	Together	A10	N/A	N/A	N/A	N/A	N/A	N/A	N/A	
	Pajero	2013	>	✓	✓	x	x	Analogue	0	1	1	0	1	0	1	0	16	N/A	N/A	TC	Together	A10	N/A	N/A	N/A	N/A	N/A	N/A	N/A	
	Pajero	2013	>	✓	✓	x	x	Analogue	0	1	1	0	1	0	1	0	16	N/A	N/A	TC	Together	A10	N/A	N/A	N/A	N/A	N/A	N/A	N/A	
	Pajero	2013	>	✓	✓	x	x	Analogue	0	1	1	0	1	0	1	0	16	N/A	N/A	TC	Together	A10	N/A	N/A	N/A	N/A	N/A	N/A	N/A	
	Pajero	2013	>	✓	✓	x	x	Analogue	0	1	1	0	1	0	1	0	16	N/A	N/A	TC	Together	A10	N/A	N/A	N/A	N/A	N/A	N/A	N/A	
	Pajero	2013	>	✓	✓	x	x	Analogue	0	1	1	0	1	0	1	0	16	N/A	N/A	TC	Together	A10	N/A	N/A	N/A	N/A	N/A	N/A	N/A	
	RVR	2010	>	✓	✓	x	x	Analogue	0	1	1	0	1	0	1	0	16	N/A	N/A	TC	Together	A10	N/A	N/A	N/A	N/A	N/A	N/A	N/A	
	RVR	2010	>	✓	✓	x	x	Analogue	0	1	1	0	1	0	1	0	16	N/A	N/A	TC	Together	A10	N/A	N/A	N/A	N/A	N/A	N/A	N/A	
	RVR	2010	>	✓	✓	x	x	Analogue	0	1	1	0	1	0	1	0	16	N/A	N/A	TC	Together	A10	N/A	N/A	N/A	N/A	N/A	N/A	N/A	
RVR	2010	>	✓	✓	x	x	Analogue	0	1	1	0	1	0	1	0	16	N/A	N/A	TC	Together	A10	N/A	N/A	N/A	N/A	N/A	N/A	N/A		
Shogun	2013	>	✓	✓	x	x	Analogue	0	1	1	0	1	0	1	0	16	N/A	N/A	TC	Together	A10	N/A	N/A	N/A	N/A	N/A	N/A	N/A		
Shogun	2013	>	✓	✓	x	x	Analogue	0	1	1	0	1	0	1	0	16	N/A	N/A	TC	Together	A10	N/A	N/A	N/A	N/A	N/A	N/A	N/A		
Shogun	2013	>	✓	✓	x	x	Analogue	0	1	1	0	1	0	1	0	16	N/A	N/A	TC	Together	A10	N/A	N/A	N/A	N/A	N/A	N/A	N/A		
Shogun	2013	>	✓	✓	x	x	Analogue	0	1	1	0	1	0	1	0	16	N/A	N/A	TC	Together	A10	N/A	N/A	N/A	N/A	N/A	N/A	N/A		
Space Star	2015	>	✓	✓	x	x	Analogue	0	1	1	0	1	0	1	0	16	N/A	N/A	TC	Together	A10	N/A	N/A	N/A	N/A	N/A	N/A	N/A		
Space Star	2015	>	✓	✓	x	x	Analogue	0	1	1	0	1	0	1	0	16	N/A	N/A	TC	Together	A10	N/A	N/A	N/A	N/A	N/A	N/A	N/A		
Space Star	2015	>	✓	✓	x	x	Analogue	0	1	1	0	1	0	1	0	16	N/A	N/A	TC	Together	A10	N/A	N/A	N/A	N/A	N/A	N/A	N/A		
Triton	2015	>	✓	✓	x	x	Analogue	0	1	1	0	1	0	1	0	16	N/A	N/A	TC	Together	A10	N/A	N/A	N/A	N/A	N/A	N/A	N/A		
Triton	2015	>	✓	✓	x	x	Analogue	0	1	1	0	1	0	1	0	16	N/A	N/A	TC	Together	A10	N/A	N/A	N/A	N/A	N/A	N/A	N/A		
Triton	2015	>	✓	✓	x	x	Analogue	0	1	1	0	1	0	1	0	16	N/A	N/A	TC	Together	A10	N/A	N/A	N/A	N/A	N/A	N/A	N/A		
350Z	2003	>	✓	x	x	x	Analogue	0	1	1	0	1	0	1	0	60	C4	C14	C12	Together	B1	N/A	N/A	N/A	N/A	N/A	N/A	N/A		
350Z	2003	2010	>	✓	x	x	Analogue	0	1	1	0	1	0	1	0	60	C4	C13	C11	Together	B1	N/A	N/A	N/A	N/A	N/A	N/A	N/A		
370Z	2009	2016	>	✓	x	x	Analogue	1	0	1	0	1	0	1	0	29	A5	A14	A15	Together	A18	N/A	N/A	N/A	N/A	N/A	N/A	N/A		
Almera	2000	2006	>	✓	x	x	Analogue	1	1	0	1	0	1	0	0	61	A7	A8	A6	Together	B5	N/A	N/A	N/A	N/A	N/A	N/A	N/A		
Altima	2014	2018	>	✓	x	4*	CAN	0	0	1	0	1	1	1	45	N/A	N/A	N/A	A8	A9	N/A	N/A	N/A	N/A	N/A	N/A	N/A			
Altima	1998	2016	>	✓	x	x	Analogue	1	0	1	0	1	0	1	0	29	A5	A14	A15	Together	A18	N/A	N/A	N/A	N/A	N/A	N/A	N/A		
Armada	2004	2012	>	✓	x	x	Analogue	1	0	1	0	1	0	1	0	29	A5	A14	A15	Together	A18	N/A	N/A	N/A	N/A	N/A	N/A	N/A		
Cube	2009	>	✓	✓	x	x	Analogue	1	0	1	0	1	0	1	0	20	8	17	7	Together	18	N/A	N/A	N/A	N/A	N/A	N/A	N/A		
Cube	2009	>	✓	✓	x	x	Analogue	1	0	1	0	1	0	1	0	21	A17	A8	A7	Together	A18	N/A	N/A	N/A	N/A	N/A	N/A	N/A		
Cube	2013	>	✓	✓	x	x	Analogue	1	0	1	0	1	0	1	0	20	8	17	7	Together	18	N/A	N/A	N/A	N/A	N/A	N/A	N/A		
Evalia	2013	>	✓	✓	x	x	Analogue	1	0	1	0	1	0	1	0	21	A17	A8	A7	Together	A18	N/A	N/A	N/A	N/A	N/A	N/A	N/A		
Frontier	2009	>	✓	✓	x	x	Analogue	1	0	1	0	1	0	1	0	21	A17	A8	A7	Together	18	N/A	N/A	N/A	N/A	N/A	N/A	N/A		
Frontier	2009	>	✓	✓	x	x	Analogue	1	0	1	0	1	0	1	0	21	A17	A8	A7	Together	A18	N/A	N/A	N/A	N/A	N/A	N/A	N/A		
Juke	2010	>	✓	✓	x	x	Analogue	1	0	1	0	1	0	1	0	20	8	17	7	Together	18	N/A	N/A	N/A	N/A	N/A	N/A	N/A		
Juke	2010	>	✓	✓	x	x	Analogue	1	0	1	0	1	0	1	0	21	A17	A8	A7	Together	A18	N/A	N/A	N/A	N/A	N/A	N/A	N/A		
Juke	2010	>	✓	✓	x	x	Analogue	1	0	1	0	1	0	1	0	20	8	17	7	Together	18	N/A	N/A	N/A	N/A	N/A	N/A	N/A		
March	2010	>	✓	✓	x	x	Analogue	1	0	1	0	1	0	1	0	21	A17	A8	A7	Together	A18	N/A	N/A	N/A	N/A	N/A	N/A	N/A		
March	2010	>	✓	✓	x	x	Analogue	1	0	1	0	1	0	1	0	21	A17	A8	A7	Together	A18	N/A	N/A	N/A	N/A	N/A	N/A	N/A		
Maxima	2015	>	✓	✓	x	5*	CAN	0	0	1	1	0	0	0	27	N/A	N/A	N/A	A21	A1	N/A	N/A	N/A	N/A	N/A	N/A	N/A			
Maxima	2001	2013	>	✓	✓	x	Analogue	1	0	1	1	0	0	1	0	29	A5	A14	A15	Together	A18	N/A	N/A	N/A	N/A	N/A	N/A	N/A		
Micra	2007	2010	>	✓	✓	x	Analogue	0	0	0	1	1	0	1	0	20	8	17	7	Together	18	N/A	N/A	N/A	N/A	N/A	N/A	N/A		

Man.	Model	Year From	Year To	Phone Button Support	Voice Assistant Support	Menu	Platform	Dipswitch Setting (0 - Off / 1 - On)								Diagram No.	IN6	IN7	Ana. GND	IN2	IN3	IN5	IN1	IN4	IN8	IN9	IN13	IN14	IN15	IN10
								1	2	3	4	5	6	7	8															
Nissan	Micra	2010	2018	✓	✗	✗	Analogue	1	0	1	1	0	0	1	0	20	8	17	7	Together	18	N/A	N/A	N/A	N/A	N/A	N/A	N/A		
	Micra	2002	2007	✓	✗	✗	Analogue	0	0	1	0	1	0	1	0	1	20	33	27	Together	8	N/A	N/A	N/A	N/A	N/A	N/A	N/A		
	Mirano	2014	>	✓	✗	5*	CAN	0	0	1	1	0	0	0	0	45	N/A	N/A	N/A	A11	A12	N/A	B10	N/A	N/A	N/A	N/A	N/A		
	Mirano	2003	2014	✓	✗	✗	Analogue	1	0	1	1	0	0	1	0	29	A5	A14	A15	Together	A18	N/A	N/A	N/A	N/A	N/A	N/A	N/A	N/A	
	Navara	2010	>	✓	✗	✗	Analogue	0	0	0	1	0	1	1	0	20	8	17	7	Together	18	N/A	N/A	N/A	N/A	N/A	N/A	N/A	N/A	
	Navara	2009	2016	✓	✗	✗	Analogue	1	0	1	0	1	0	1	0	20	8	17	7	Together	18	N/A	N/A	N/A	N/A	N/A	N/A	N/A	N/A	
	Navara	2015	>	✓	✗	✓	CAN	0	0	1	0	1	1	1	0	45	N/A	N/A	N/A	A8	A9	N/A	B10	N/A	N/A	N/A	N/A	N/A		
	Navara	2006	2009	✓	✗	✗	Analogue	0	1	1	1	0	0	1	0	60	C4	C14	C12	Together	B1	N/A	N/A	N/A	N/A	N/A	N/A	N/A	N/A	
	Note	2012	>	✓	✗	✗	Analogue	1	0	1	1	0	0	1	0	20	8	17	7	Together	18	N/A	N/A	N/A	N/A	N/A	N/A	N/A	N/A	
	Note	2009	2012	✓	✗	✗	Analogue	1	1	1	0	0	1	0	1	20	8	17	7	Together	18	N/A	N/A	N/A	N/A	N/A	N/A	N/A	N/A	
	NV200	2013	>	✓	✗	✗	Analogue	1	0	1	1	0	0	1	0	20	8	17	7	Together	18	N/A	N/A	N/A	N/A	N/A	N/A	N/A	N/A	
	NV200	2013	>	✓	✗	✗	Analogue	1	0	1	1	0	0	1	0	21	A17	A8	A7	Together	A18	N/A	N/A	N/A	N/A	N/A	N/A	N/A	N/A	
	NV400	2014	>	✓	✗	✗	Matrix	0	0	1	0	1	0	1	0	21	B4	B6	N/A	Together	A14	N/A	N/A	N/A	B5	N/A	B2	B3	B1	
	Pathfinder	2010	2013	✓	✗	✗	Analogue	0	0	1	0	1	0	1	0	20	8	17	7	Together	18	N/A	N/A	N/A	N/A	N/A	N/A	N/A	N/A	
	Pathfinder	2013	>	✓	✗	✗	Analogue	1	0	1	1	0	0	1	0	20	8	17	7	Together	18	N/A	N/A	N/A	N/A	N/A	N/A	N/A	N/A	
	Pathfinder	2013	>	✓	✗	✗	Analogue	1	0	1	1	0	0	1	0	21	A17	A8	A7	Together	A18	N/A	N/A	N/A	N/A	N/A	N/A	N/A	N/A	
	Primastar	2011	2014	✓	✗	✓	CAN	0	0	0	0	1	1	1	0	1	N/A	N/A	N/A	17	30	N/A	N/A	N/A	N/A	N/A	N/A	N/A	N/A	
	Primastar	2005	2010	?	✗	✓	CAN	0	0	0	0	0	1	1	0	33	N/A	N/A	N/A	B6	B2	N/A	N/A	N/A	N/A	N/A	N/A	N/A	N/A	
	Primera	2001	2007	✓	✗	✗	Analogue	1	1	1	0	1	1	0	0	61	A7	A8	A6	Together	B5	N/A	N/A	N/A	N/A	N/A	N/A	N/A	N/A	
	Pulsar	2015	>	✓	✗	4*	CAN	0	1	0	1	1	1	1	1	54	N/A	N/A	N/A	A2	A1	N/A	B10	N/A	N/A	N/A	N/A	N/A	N/A	
	Pulse	2011	>	✓	✗	✗	Analogue	1	0	1	0	0	1	0	0	20	8	17	7	Together	18	N/A	N/A	N/A	N/A	N/A	N/A	N/A	N/A	
	Pulse	2011	>	✓	✗	✗	Analogue	1	0	1	1	0	0	1	0	21	A17	A8	A7	Together	A18	N/A	N/A	N/A	N/A	N/A	N/A	N/A	N/A	
	Qashqai	2007	2013	✓	✗	✗	Analogue	0	0	1	0	1	0	1	0	20	8	17	7	Together	18	N/A	N/A	N/A	N/A	N/A	N/A	N/A	N/A	
	Qashqai	2014	>	✓	✗	4*	CAN	0	0	1	0	1	1	1	1	45	N/A	N/A	N/A	A20	A21	N/A	B10	N/A	N/A	N/A	N/A	N/A	N/A	
	Qashqai	2014	>	✓	✗	4*	CAN	0	0	1	0	1	1	1	1	54	N/A	N/A	N/A	A2	A1	N/A	B10	N/A	N/A	N/A	N/A	N/A	N/A	
	Quest	2010	>	✓	✗	✗	Analogue	1	0	1	0	0	1	0	0	20	8	17	7	Together	18	N/A	N/A	N/A	N/A	N/A	N/A	N/A	N/A	
	Quest	2010	>	✓	✗	✗	Analogue	1	0	1	0	0	1	0	0	21	A17	A8	A7	Together	A18	N/A	N/A	N/A	N/A	N/A	N/A	N/A	N/A	
	Rogue	2007	2013	✓	✗	✗	Analogue	1	0	1	1	0	0	1	0	20	8	17	7	Together	18	N/A	N/A	N/A	N/A	N/A	N/A	N/A	N/A	
	Skyline	2001	2007	✓	✗	✗	Analogue	0	0	0	1	0	1	1	0	59	C4	C13	C11	Together	B1	N/A	N/A	N/A	N/A	N/A	N/A	N/A	N/A	
	Sunny	2012	>	✓	✗	✗	Analogue	1	0	1	0	1	0	1	0	20	8	17	7	Together	18	N/A	N/A	N/A	N/A	N/A	N/A	N/A	N/A	
Sunny	2012	>	✓	✗	✗	Analogue	1	0	1	1	0	0	1	0	21	A17	A8	A7	Together	A18	N/A	N/A	N/A	N/A	N/A	N/A	N/A	N/A		
Terrano	2001	2006	✓	✗	✗	Analogue	1	1	1	0	1	0	1	0	61	A7	A8	A6	Together	B5	N/A	N/A	N/A	N/A	N/A	N/A	N/A	N/A		
Tiida	2007	2014	✓	✗	✗	Analogue	1	1	1	0	0	1	0	0	20	8	17	7	Together	18	N/A	N/A	N/A	N/A	N/A	N/A	N/A	N/A		
Tiida	2009	>	✓	✗	✗	Analogue	1	0	1	1	0	0	1	0	20	8	17	7	Together	18	N/A	N/A	N/A	N/A	N/A	N/A	N/A	N/A		
Titan	2009	>	✓	✗	✗	Analogue	1	0	1	1	0	0	1	0	21	A17	A8	A7	Together	A18	N/A	N/A	N/A	N/A	N/A	N/A	N/A	N/A		
Titan	2009	>	✓	✗	✗	Analogue	1	0	1	0	0	1	0	0	21	A17	A8	A7	Together	A18	N/A	N/A	N/A	N/A	N/A	N/A	N/A	N/A		
Versa	2008	>	✓	✗	✗	Analogue	1	0	1	1	0	0	1	0	20	8	17	7	Together	18	N/A	N/A	N/A	N/A	N/A	N/A	N/A	N/A		
Versa	2008	>	✓	✗	✗	Analogue	1	0	1	0	0	1	0	0	21	A17	A8	A7	Together	A18	N/A	N/A	N/A	N/A	N/A	N/A	N/A	N/A		
Xterra	2009	2016	✓	✗	✗	Analogue	1	0	1	1	0	0	1	0	20	8	17	7	Together	18	N/A	N/A	N/A	N/A	N/A	N/A	N/A	N/A		
Xterra	2009	>	✓	✗	✗	Analogue	1	0	1	1	0	0	1	0	21	A17	A8	A7	Together	A18	N/A	N/A	N/A	N/A	N/A	N/A	N/A	N/A		
X-Trail	2009	2014	✓	✗	✗	Analogue	0	0	0	1	0	1	1	0	20	8	17	7	Together	18	N/A	N/A	N/A	N/A	N/A	N/A	N/A	N/A		
X-Trail	2014	>	✓	✗	4*	CAN	0	0	1	0	1	1	1	1	54	N/A	N/A	N/A	A2	A1	N/A	B10	N/A	N/A	N/A	N/A	N/A	N/A		
X-Trail	2001	2008	✓	✗	✗	Analogue	1	1	1	0	1	1	0	0	61	A7	A8	A6	Together	B5	N/A	N/A	N/A	N/A	N/A	N/A	N/A	N/A		
Alero	2002	2004	✓	✗	✗	Class II	1	1	1	0	0	0	1	1	8	N/A	N/A	N/A	Together	N/A	N/A	N/A	N/A	N/A	N/A	N/A	N/A	N/A		
Alero	2002	2004	✓	✗	✗	Class II	1	1	1	0	0	0	1	1	8	N/A	N/A	N/A	Together	N/A	N/A	N/A	N/A	N/A	N/A	N/A	N/A	N/A		
Bravada	2000	2001	✓	✗	✗	Class II	1	1	1	0	0	0	1	1	8	N/A	N/A	N/A	Together	N/A	N/A	N/A	N/A	N/A	N/A	N/A	N/A	N/A		
Silhouette	2000	2001	✓	✗	✗	Class II	1	1	1	0	0	0	1	1	8	N/A	N/A	N/A	Together	N/A	N/A	N/A	N/A	N/A	N/A	N/A	N/A	N/A		
108	2014	>	✓	✗	✗	Analogue	1	1	1	0	1	0	1	0	17	B20	B19	B21	Together	A2	N/A	N/A	N/A	N/A	N/A	N/A	N/A	N/A		
206	1998	2002	✓	✗	✗	Analogue	0	1	0	0	0	1	0	0	1	17	30	24	Together	2	N/A	N/A	N/A	N/A	N/A	N/A	N/A	N/A		
206	2009	>	✓	✗	✗	Analogue	0	1	0	1	1	0	1	0	2	35	34	38	Together	12	N/A	N/A	N/A	N/A	N/A	N/A	N/A	N/A		
206	2006	2012	✓	✗	1*	CAN	0	1	0	0	1	1	0	0	2	N/A	N/A	N/A	10	13	N/A	N/A	N/A	N/A	N/A	N/A	N/A	N/A		
208	2012	>	✓	✗	1*	CAN	0	1	0	0	1	1	1	0	2	N/A	N/A	N/A	10	13	N/A	N/A	N/A	N/A	N/A	N/A	N/A	N/A		
306	1998	2002	✓	✗	✗	Analogue	0	1	0	0	0	1	0	0	1	17	30	24	Together	2	N/A	N/A	N/A	N/A	N/A	N/A	N/A	N/A		
307	2005	2008	✓	✗	1*	CAN	0	1	0	0	1	1	0	0	2	N/A	N/A	N/A	10	13	N/A	N/A	N/A	N/A	N/A	N/A	N/A	N/A		
308	2007	>	✓	✗	1*	CAN	0	1	0	0	1	1	1	0	2	N/A	N/A	N/A	10	13	N/A	N/A	N/A	N/A	N/A	N/A	N/A	N/A		
407	2004	2010	✓	✗	1*	CAN	0	1	0	0	1	1	1	0	2	N/A	N/A	N/A	10	13	N/A	N/A	N/A	N/A	N/A	N/A	N/A	N/A		
607	2005	2012	✓	✗	1*	CAN	0	1	0	0	1	1	1	0	2	N/A	N/A	N/A	10	13	N/A	N/A	N/A	N/A	N/A	N/A	N/A	N/A		
806	1996	2002	✓	✗	✗	Analogue	0	1	0	0	0	1	1	0	1	17	30	24	Together	2	N/A	N/A	N/A	N/A	N/A	N/A	N/A	N/A		
807	2005	2014	✓	✗	1*	CAN	0	1	0	0	1	1	1	0	2	N/A	N/A	N/A	10	13	N/A	N/A	N/A	N/A	N/A	N/A	N/A	N/A		
3008	2009	>	✓	✗	1*	CAN	0	1	0	0	1	1	1	0	2	N/A	N/A	N/A	10	13	N/A	N/A	N/A	N/A	N/A	N/A	N/A	N/A		

Man.	Model	Year From	Year To	Phone Button Support	Voice Assistant Support	Menu	Platform	Dipswitch Setting (0 - Off / 1 - On)								Diagram No.	IN6	IN7	Ana. GND	IN2	IN3	IN5	IN1	IN4	IN8	IN9	IN13	IN14	IN15	IN10
								1	2	3	4	5	6	7	8															
Renault	Modus	2004	2012	x	x	✓	CAN	0	0	0	0	0	0	1	33	N/A	N/A	N/A	B6	B2	N/A	N/A	N/A	N/A	N/A	N/A	N/A	N/A		
	Scala	2011	>	✓	x	x	Analogue	1	0	1	0	0	1	0	20	8	17	7	Together	Together	18	N/A	N/A	N/A	N/A	N/A	N/A	N/A		
	Scenic	2000	2005	✓	x	x	Matrix	0	0	1	0	0	1	0	33	B4	B2	N/A	Together	Together	A8	N/A	N/A	N/A	N/A	N/A	N/A	N/A		
	Scenic	2009	>	✓	x	6*	CAN	0	0	0	1	1	1	0	2	N/A	N/A	N/A	13	9	N/A	N/A	N/A	N/A	N/A	N/A	N/A	N/A		
	Scenic	2009	>	✓	x	6*	CAN	0	0	0	0	1	1	1	0	1	N/A	N/A	N/A	17	30	N/A	N/A	N/A	N/A	N/A	N/A	N/A	N/A	
	Scenic	2005	2009	x	x	✓	CAN	0	0	0	0	0	0	1	33	B4	B2	N/A	Together	Together	A8	N/A	N/A	N/A	N/A	N/A	N/A	N/A	N/A	
	Trafic	2000	2005	✓	x	x	Matrix	0	0	1	0	1	0	1	33	B4	B2	N/A	Together	Together	A8	N/A	N/A	N/A	N/A	N/A	N/A	N/A	N/A	
	Trafic	2010	2013	✓	x	6*	CAN	0	0	0	0	1	1	1	1	N/A	N/A	N/A	17	30	N/A	N/A	N/A	N/A	N/A	N/A	N/A	N/A	N/A	
	Trafic	2006	2010	x	x	✓	CAN	0	0	0	0	0	0	1	33	N/A	N/A	N/A	B6	B2	N/A	N/A	N/A	N/A	N/A	N/A	N/A	N/A	N/A	N/A
	Twingo	2000	2007	✓	x	x	Matrix	0	0	1	0	1	0	1	33	B4	B2	N/A	Together	Together	A8	N/A	N/A	N/A	N/A	N/A	N/A	N/A	N/A	N/A
Rover	Twingo	2007	2009	x	x	✓	CAN	0	0	0	0	0	1	33	N/A	N/A	N/A	B6	B2	N/A	N/A	N/A	N/A	N/A	N/A	N/A	N/A	N/A	N/A	
	Wind	2010	2013	✓	x	6*	CAN	0	0	0	0	1	1	0	2	N/A	N/A	N/A	13	9	N/A	N/A	N/A	N/A	N/A	N/A	N/A	N/A	N/A	
	Wind	2010	2013	✓	x	6*	CAN	0	0	0	1	1	1	0	1	N/A	N/A	N/A	17	30	N/A	N/A	N/A	N/A	N/A	N/A	N/A	N/A	N/A	
	Wind	2010	2013	✓	x	x	CAN	0	1	0	0	1	1	0	6	N/A	N/A	N/A	17	30	N/A	N/A	N/A	N/A	N/A	N/A	N/A	N/A	N/A	
	25	2000	2005	x	x	x	Analogue	0	1	0	0	1	1	1	6	16	N/A	N/A	N/A	Together	Together	S12V*	N/A	N/A	N/A	N/A	N/A	N/A	N/A	
	25	2000	2005	x	x	x	Analogue	0	0	0	0	1	1	1	1	20	N/A	N/A	27	Together	Together	2	N/A	N/A	N/A	N/A	N/A	N/A	N/A	
	45	2000	2005	x	x	x	Analogue	0	1	0	0	1	1	1	6	16	N/A	N/A	N/A	Together	Together	S12V*	N/A	N/A	N/A	N/A	N/A	N/A	N/A	
	45	2000	2005	x	x	x	Analogue	0	0	0	0	1	1	1	1	20	N/A	N/A	27	Together	Together	2	N/A	N/A	N/A	N/A	N/A	N/A	N/A	
	75	2000	2005	x	x	x	Analogue	0	1	0	0	1	1	1	6	16	N/A	N/A	N/A	Together	Together	S12V*	N/A	N/A	N/A	N/A	N/A	N/A	N/A	
	75	2000	2005	x	x	x	Analogue	0	0	0	0	1	1	1	1	20	N/A	N/A	27	Together	Together	2	N/A	N/A	N/A	N/A	N/A	N/A	N/A	
Saab	9-3	2008	2014	✓	x	x	Class II	0	0	0	0	0	1	0	1	20	N/A	N/A	N/A	Together	Together	A13	N/A	N/A	N/A	N/A	N/A	N/A	N/A	
	9-3	1998	2002	x	x	x	Class II	0	0	1	0	1	1	1	3	N/A	N/A	N/A	Together	Together	2	N/A	N/A	N/A	N/A	N/A	N/A	N/A	N/A	
	9-5	2008	2010	✓	x	x	Class II	0	0	0	0	0	0	0	8	N/A	N/A	N/A	Together	Together	N/A	N/A	N/A	N/A	N/A	N/A	N/A	N/A	N/A	
	9-5	1998	2005	x	x	x	Analogue	0	0	1	0	1	1	1	3	N/A	N/A	N/A	Together	Together	2	N/A	N/A	N/A	N/A	N/A	N/A	N/A	N/A	
	9-5	1998	2005	x	x	x	Class II	0	0	0	0	0	0	0	8	N/A	N/A	N/A	Together	Together	N/A	N/A	N/A	N/A	N/A	N/A	N/A	N/A	N/A	
	Aura	2007	2007	✓	x	x	Class II	1	1	1	0	0	0	1	8	N/A	N/A	N/A	Together	Together	N/A	N/A	N/A	N/A	N/A	N/A	N/A	N/A	N/A	
	Aura	2007	2009	x	x	x	CAN (SW)	1	1	1	0	1	0	1	8	N/A	N/A	N/A	Together	Together	N/A	N/A	N/A	N/A	N/A	N/A	N/A	N/A	N/A	
	Outlook	2007	2009	x	x	x	CAN (SW)	1	1	1	0	1	0	1	8	N/A	N/A	N/A	Together	Together	N/A	N/A	N/A	N/A	N/A	N/A	N/A	N/A	N/A	
	Sky	2007	2009	x	x	x	CAN (SW)	1	1	1	0	1	0	1	8	N/A	N/A	N/A	Together	Together	N/A	N/A	N/A	N/A	N/A	N/A	N/A	N/A	N/A	N/A
	Vue	2006	2007	x	x	x	CAN (SW)	1	1	1	0	1	0	1	8	N/A	N/A	N/A	Together	Together	N/A	N/A	N/A	N/A	N/A	N/A	N/A	N/A	N/A	N/A
Scania	Vue	2006	2009	✓	x	x	Analogue	1	1	1	0	1	0	1	8	N/A	N/A	N/A	Together	Together	N/A	N/A	N/A	N/A	N/A	N/A	N/A	N/A	N/A	
	XL7	2007	2009	x	x	x	CAN (SW)	1	1	1	0	1	0	1	8	N/A	N/A	N/A	Together	Together	N/A	N/A	N/A	N/A	N/A	N/A	N/A	N/A	N/A	
	R Series	2004	2015	x	x	x	CAN	1	0	0	0	1	1	0	3	N/A	N/A	N/A	5	1	N/A	N/A	N/A	N/A	N/A	N/A	N/A	N/A	N/A	
	iQ	2012	2013	✓	x	x	Analogue	1	1	1	0	1	0	1	12	A8	A7	A6	Together	Together	B3	N/A	N/A	N/A	N/A	N/A	N/A	N/A	N/A	
	TC	2006	2015	✓	x	x	Analogue	1	1	0	1	0	1	0	12	A8	A7	A6	Together	Together	B3	N/A	N/A	N/A	N/A	N/A	N/A	N/A	N/A	
	xA	2006	2006	✓	x	x	Analogue	1	1	0	1	0	1	0	12	A8	A7	A6	Together	Together	B3	N/A	N/A	N/A	N/A	N/A	N/A	N/A	N/A	
	xB	2006	2012	✓	x	x	Analogue	1	1	0	1	0	1	0	12	A8	A7	A6	Together	Together	B3	N/A	N/A	N/A	N/A	N/A	N/A	N/A	N/A	
	xD	2008	2013	✓	x	x	Analogue	1	1	0	1	0	1	0	12	A8	A7	A6	Together	Together	B3	N/A	N/A	N/A	N/A	N/A	N/A	N/A	N/A	N/A
	Alhambra	2015	>	✓	x	x	CAN (FT)	1	1	0	1	0	1	0	5	N/A	N/A	N/A	22	28	N/A	N/A	N/A	N/A	N/A	N/A	N/A	N/A	N/A	
	Altea	2004	2015	✓	x	x	CAN (FT)	1	1	0	1	0	1	0	2	N/A	N/A	N/A	N/A	9	10	N/A	N/A	N/A	N/A	N/A	N/A	N/A	N/A	
Seat	Altea	2009	2013	✓	x	x	CAN	1	1	0	1	1	1	0	1	N/A	N/A	N/A	30	17	N/A	N/A	N/A	N/A	N/A	N/A	N/A	N/A		
	Exeo	2009	2013	✓	x	x	CAN	1	1	0	1	1	1	0	2	N/A	N/A	N/A	9	10	N/A	N/A	N/A	N/A	N/A	N/A	N/A	N/A		
	Exeo	2009	2013	✓	x	x	CAN	1	1	0	1	1	1	0	2	N/A	N/A	N/A	9	10	N/A	N/A	N/A	N/A	N/A	N/A	N/A	N/A		
	Ibiza	2008	2016	✓	x	x	CAN (FT)	1	1	0	1	0	1	0	2	N/A	N/A	N/A	9	10	N/A	N/A	N/A	N/A	N/A	N/A	N/A	N/A	N/A	
	Leon	2005	2012	✓	x	x	CAN (FT)	1	1	0	1	0	1	0	2	N/A	N/A	N/A	9	10	N/A	N/A	N/A	N/A	N/A	N/A	N/A	N/A	N/A	
	Toledo	2005	>	✓	x	x	CAN (FT)	1	1	0	1	1	0	1	2	N/A	N/A	N/A	9	10	N/A	N/A	N/A	N/A	N/A	N/A	N/A	N/A	N/A	
	Fabia	2013	>	✓	x	x	CAN (FT)	1	1	0	1	0	1	0	2	N/A	N/A	N/A	9	10	N/A	N/A	N/A	N/A	N/A	N/A	N/A	N/A	N/A	
	Fabia	2007	2014	x	x	x	CAN	1	1	0	1	1	1	1	0	2	N/A	N/A	N/A	9	10	N/A	N/A	N/A	N/A	N/A	N/A	N/A	N/A	
	Octavia	2008	2013	✓	x	x	CAN (FT)	1	1	0	1	1	0	1	2	N/A	N/A	N/A	9	10	N/A	N/A	N/A	N/A	N/A	N/A	N/A	N/A	N/A	
	Octavia	2004	2008	x	x	x	CAN	1	1	0	0	1	1	1	0	2	N/A	N/A	N/A	9	10	N/A	N/A	N/A	N/A	N/A	N/A	N/A	N/A	
Skoda	Rapid	2012	2015	✓	x	x	CAN (FT)	1	1	0	1	0	1	0	2	N/A	N/A	N/A	9	10	N/A	N/A	N/A	N/A	N/A	N/A	N/A	N/A	N/A	
	Roomster	2008	2015	✓	x	x	CAN (FT)	1	1	0	1	1	1	0	2	N/A	N/A	N/A	9	10	N/A	N/A	N/A	N/A	N/A	N/A	N/A	N/A	N/A	
	Superb	2008	2013	✓	x	x	CAN (FT)	1	1	0	1	1	0	1	2	N/A	N/A	N/A	9	10	N/A	N/A	N/A	N/A	N/A	N/A	N/A	N/A	N/A	
	Superb	2009	2014	✓	x	x	CAN (FT)	1	1	0	1	1	0	1	2	N/A	N/A	N/A	9	10	N/A	N/A	N/A	N/A	N/A	N/A	N/A	N/A	N/A	
	Yeti	2009	2014	✓	x	x	CAN (FT)	1	1	0	1	1	0	1	2	N/A	N/A	N/A	9	10	N/A	N/A	N/A	N/A	N/A	N/A	N/A	N/A	N/A	
	Actyon	2006	>	✓	x																									

Man.	Model	Year From	Year To	Phone Button Support	Voice Assistant Support	Menu	Platform	Dipswitch Setting (0 - Off / 1 - On)								Diagram No.	IN6	IN7	Ana. GND	IN2	IN3	IN5	IN1	IN4	IN8	IN9	IN13	IN14	IN15	IN10				
								1	2	3	4	5	6	7	8																			
SsangYong	Rexton	2007	2012	✓	*	*	Analogue	0	0	0	1	1	0	1	0	11	16	N/A	17	Together	4	N/A	N/A	N/A	N/A	N/A	N/A	N/A	N/A					
	Rexton	2007	>	✓	*	*	Analogue	0	0	0	1	1	0	1	0	11	N/A	N/A	13	Together	4	N/A	N/A	N/A	N/A	N/A	N/A	N/A	N/A					
	Rexton II	2005	2008	✓	*	*	Analogue	0	0	0	1	1	0	1	0	11	N/A	N/A	13	Together	4	N/A	N/A	N/A	N/A	N/A	N/A	N/A	N/A					
	Rexton W	2013	>	✓	*	*	Analogue	0	0	0	1	1	0	1	0	11	N/A	N/A	13	Together	4	N/A	N/A	N/A	N/A	N/A	N/A	N/A	N/A	N/A				
	Rodius	2013	2015	✓	*	*	Analogue	0	0	0	1	1	0	1	0	11	16	N/A	18	Together	4	N/A	N/A	N/A	N/A	N/A	N/A	N/A	N/A	N/A	N/A			
	Rodius	2015	2018	✓	*	*	Analogue	0	0	0	1	1	0	1	0	11	N/A	N/A	13	Together	4	N/A	N/A	N/A	N/A	N/A	N/A	N/A	N/A	N/A	N/A			
	Rodius Turismo	2013	>	✓	*	*	Analogue	0	0	0	1	1	0	1	0	11	N/A	N/A	13	Together	4	N/A	N/A	N/A	N/A	N/A	N/A	N/A	N/A	N/A	N/A	N/A		
	Stavic	2013	>	✓	*	*	Analogue	0	0	0	1	1	0	1	0	22	N/A	N/A	13	Together	4	N/A	N/A	N/A	N/A	N/A	N/A	N/A	N/A	N/A	N/A	N/A		
	Tivoli	2015	>	✓	*	*	Analogue	1	0	0	1	1	1	0	0	22	A17	N/A	A4	Together	A11	N/A	N/A	N/A	N/A	N/A	N/A	N/A	N/A	N/A	N/A	N/A	N/A	
	Tivoli	2015	>	✓	*	*	Analogue	1	0	0	1	1	1	0	0	22	B9	N/A	A8	Together	A11	N/A	N/A	N/A	N/A	N/A	N/A	N/A	N/A	N/A	N/A	N/A	N/A	N/A
	Forester	2007	2011	✓	*	*	Analogue	1	0	0	1	1	1	0	0	20	17	N/A	7	Together	18	N/A	N/A	N/A	N/A	N/A	N/A	N/A	N/A	N/A	N/A	N/A	N/A	N/A
	Forester	2012	>	✓	*	*	Analogue	1	0	0	1	0	1	0	1	20	17	8	7	Together	18	N/A	N/A	N/A	N/A	N/A	N/A	N/A	N/A	N/A	N/A	N/A	N/A	N/A
	Forester	2004	2007	✓	*	*	Analogue	1	0	0	1	1	1	0	0	56	B2	N/A	B6	Together	S12V*	N/A	N/A	N/A	N/A	N/A	N/A	N/A	N/A	N/A	N/A	N/A	N/A	N/A
	Impreza	2012	2015	✓	*	*	Analogue	1	0	0	1	1	0	1	0	20	17	8	7	Together	18	N/A	N/A	N/A	N/A	N/A	N/A	N/A	N/A	N/A	N/A	N/A	N/A	N/A
	Impreza	2007	2011	✓	*	*	Analogue	1	0	0	1	1	1	0	0	52	B3	N/A	B15	Together	S12V*	N/A	N/A	N/A	N/A	N/A	N/A	N/A	N/A	N/A	N/A	N/A	N/A	N/A
Impreza	2017	>	✓	*	*	Analogue	0	0	1	0	0	1	0	1	57	A21	A22	A20	Together	C2	N/A	N/A	N/A	N/A	N/A	N/A	N/A	N/A	N/A	N/A	N/A	N/A	N/A	
Legacy	2008	2010	✓	*	*	Analogue	1	0	0	1	1	1	0	0	20	17	N/A	7	Together	18	N/A	N/A	N/A	N/A	N/A	N/A	N/A	N/A	N/A	N/A	N/A	N/A	N/A	
Legacy	2008	2010	✓	*	*	Analogue	1	0	0	1	1	1	0	0	20	17	N/A	7	Together	18	N/A	N/A	N/A	N/A	N/A	N/A	N/A	N/A	N/A	N/A	N/A	N/A	N/A	
Outback	2014	>	✓	*	*	Analogue	0	1	1	1	1	0	1	0	43	A21	A22	A23	Together	B5	N/A	N/A	N/A	N/A	N/A	N/A	N/A	N/A	N/A	N/A	N/A	N/A	N/A	
Outback	2012	>	✓	*	*	Analogue	1	0	0	1	0	1	0	1	20	17	8	7	Together	18	N/A	N/A	N/A	N/A	N/A	N/A	N/A	N/A	N/A	N/A	N/A	N/A	N/A	
Outback	2012	>	✓	*	*	Analogue	1	0	0	1	0	1	0	1	20	17	8	7	Together	18	N/A	N/A	N/A	N/A	N/A	N/A	N/A	N/A	N/A	N/A	N/A	N/A	N/A	
XV	2015	>	✓	*	*	Analogue	0	1	1	1	1	0	1	0	43	A21	A22	A23	Together	B5	N/A	N/A	N/A	N/A	N/A	N/A	N/A	N/A	N/A	N/A	N/A	N/A	N/A	
XV	2015	2015	✓	*	*	Analogue	1	0	0	1	0	1	0	1	20	17	8	7	Together	18	N/A	N/A	N/A	N/A	N/A	N/A	N/A	N/A	N/A	N/A	N/A	N/A	N/A	
XV Crosstrek	2013	?	✓	*	*	Analogue	1	0	0	1	0	1	1	0	57	A21	A22	A20	Together	C2	N/A	N/A	N/A	N/A	N/A	N/A	N/A	N/A	N/A	N/A	N/A	N/A	N/A	
Aerio	2005	2007	✓	*	*	Analogue	1	0	0	1	0	1	1	0	10	19	8	20	Together	S12V*	N/A	N/A	N/A	N/A	N/A	N/A	N/A	N/A	N/A	N/A	N/A	N/A	N/A	
Aerio	2008	2010	✓	*	*	Analogue	1	0	0	1	0	1	1	0	10	19	8	20	Together	9	N/A	N/A	N/A	N/A	N/A	N/A	N/A	N/A	N/A	N/A	N/A	N/A	N/A	
Dzire	2012	2015	✓	*	*	Analogue	1	0	0	1	0	1	1	0	10	19	8	20	Together	9	N/A	N/A	N/A	N/A	N/A	N/A	N/A	N/A	N/A	N/A	N/A	N/A	N/A	
Ertiga	2012	2015	✓	*	*	Analogue	1	0	0	1	0	1	1	0	11	16	N/A	13	N/A	N/A	4	N/A	N/A	N/A	N/A	N/A	N/A	N/A	N/A	N/A	N/A	N/A		
Forenza	2004	2008	✓	*	*	Analogue	1	0	0	1	0	1	1	0	10	19	8	20	Together	9	N/A	N/A	N/A	N/A	N/A	N/A	N/A	N/A	N/A	N/A	N/A	N/A	N/A	
Grand Nomade	<	2009	✓	*	*	Analogue	1	0	0	1	0	1	1	0	10	19	8	20	Together	9	N/A	N/A	N/A	N/A	N/A	N/A	N/A	N/A	N/A	N/A	N/A	N/A	N/A	
Grand-Vitara	2005	2012	✓	*	*	Analogue	1	0	0	1	0	1	1	0	10	19	8	20	Together	9	N/A	N/A	N/A	N/A	N/A	N/A	N/A	N/A	N/A	N/A	N/A	N/A	N/A	N/A
Grand-Vitara	2005	2012	✓	*	*	Analogue	1	0	0	1	0	1	1	0	10	19	8	20	Together	9	N/A	N/A	N/A	N/A	N/A	N/A	N/A	N/A	N/A	N/A	N/A	N/A	N/A	
Ignis	2017	>	✓	*	*	Analogue	1	0	0	1	0	1	1	0	10	19	8	20	Together	9	N/A	N/A	N/A	N/A	N/A	N/A	N/A	N/A	N/A	N/A	N/A	N/A	N/A	
Ignis	2017	>	✓	*	*	Analogue	1	0	0	1	0	1	1	0	10	19	8	20	Together	9	N/A	N/A	N/A	N/A	N/A	N/A	N/A	N/A	N/A	N/A	N/A	N/A	N/A	
Kizashi	2010	2012	✓	*	*	Analogue	1	0	0	1	0	1	1	0	10	19	8	20	Together	S12V*	N/A	N/A	N/A	N/A	N/A	N/A	N/A	N/A	N/A	N/A	N/A	N/A	N/A	
Kizashi	2010	2012	✓	*	*	Analogue	1	0	0	1	0	1	1	0	10	19	8	20	Together	9	N/A	N/A	N/A	N/A	N/A	N/A	N/A	N/A	N/A	N/A	N/A	N/A	N/A	
Reno	2005	2008	✓	*	*	Analogue	1	0	0	1	0	1	1	0	11	16	N/A	13	N/A	N/A	4	N/A	N/A	N/A	N/A	N/A	N/A	N/A	N/A	N/A	N/A	N/A		
Reno	2005	2008	✓	*	*	Analogue	1	0	0	1	0	1	1	0	11	16	N/A	13	N/A	N/A	4	N/A	N/A	N/A	N/A	N/A	N/A	N/A	N/A	N/A	N/A	N/A		
Ritz	2009	>	✓	*	*	Analogue	1	0	0	1	0	1	1	0	10	19	8	20	Together	9	N/A	N/A	N/A	N/A	N/A	N/A	N/A	N/A	N/A	N/A	N/A	N/A	N/A	
Splash	2008	>	✓	*	*	Analogue	1	0	0	1	0	1	1	0	10	19	8	20	Together	9	N/A	N/A	N/A	N/A	N/A	N/A	N/A	N/A	N/A	N/A	N/A	N/A	N/A	
Splash	2008	>	✓	*	*	Analogue	1	0	0	1	0	1	1	0	10	19	8	20	Together	9	N/A	N/A	N/A	N/A	N/A	N/A	N/A	N/A	N/A	N/A	N/A	N/A	N/A	
Swift	2005	2011	✓	*	*	Analogue	1	0	0	1	0	1	1	0	10	19	8	20	Together	9	N/A	N/A	N/A	N/A	N/A	N/A	N/A	N/A	N/A	N/A	N/A	N/A	N/A	
Swift	2011	>	✓	*	*	Analogue	1	0	0	1	0	1	1	0	10	19	8	20	Together	9	N/A	N/A	N/A	N/A	N/A	N/A	N/A	N/A	N/A	N/A	N/A	N/A	N/A	
Swift	2017	>	✓	*	*	Analogue	1	0	0	1	0	1	1	0	10	19	8	20	Together	9	N/A	N/A	N/A	N/A	N/A	N/A	N/A	N/A	N/A	N/A	N/A	N/A	N/A	
Swift	2017	>	✓	*	*	Analogue	1	0	0	1	0	1	1	0	10	19	8	20	Together	9	N/A	N/A	N/A	N/A	N/A	N/A	N/A	N/A	N/A	N/A	N/A	N/A	N/A	
SK4	2006	2014	✓	*	*	Analogue	1	0	0	1	0	1	1	0	10	19	8	20	Together	9	N/A	N/A	N/A	N/A	N/A	N/A	N/A	N/A	N/A	N/A	N/A	N/A	N/A	
SK4	2006	2014	✓	*	*	Analogue	1	0	0	1	0	1	1	0	10	19	8	20	Together	9	N/A	N/A	N/A	N/A	N/A	N/A	N/A	N/A	N/A	N/A	N/A	N/A	N/A	
SK4 S-Cross	2013	>	✓	*	*	Analogue	1	0	0	1	0	1	1	0	10	19	8	20	Together	9	N/A	N/A	N/A	N/A	N/A	N/A	N/A	N/A	N/A	N/A	N/A	N/A	N/A	
SK4 S-Cross	2013	>	✓	*	*	Analogue	1	0	0	1	0	1	1	0	10	19	8	20	Together	9	N/A	N/A	N/A	N/A	N/A	N/A	N/A	N/A	N/A	N/A	N/A	N/A	N/A	
Verona	2004	2007	✓	*	*	Analogue	1	0	0	1	0	1	1	0	11	16	N/A	13	N/A	N/A	4	N/A	N/A	N/A	N/A	N/A	N/A	N/A	N/A	N/A	N/A	N/A		
Verona	2004	2007	✓	*	*	Analogue	1	0	0																									

Man.	Model	Year From	Year To	Phone Button Support	Voice Assistant Support	Menu	Platform	Dipswitch Setting (0 - Off / 1 - On)								Diagram No.	IN6	IN7	Ana. GND	IN2	IN3	IN5	IN1	IN4	IN8	IN9	IN13	IN14	IN15	IN10		
								1	2	3	4	5	6	7	8																	
Toyota	Fortuner	2005	>	✓	x	x	Analogue	1	1	1	0	1	0	1	0	58	A5/B5	A15/B15	A20/B20	Together	A11/B11	N/A	N/A	N/A	N/A	N/A	N/A	N/A	N/A			
	Highlander	2004	2014	✓	x	x	Analogue	1	1	1	0	1	0	1	0	12	A8	A7	A6	Together	B3	N/A	N/A	N/A	N/A	N/A	N/A	N/A	N/A			
	Hilux	2012	>	✓	x	x	Analogue	1	1	1	0	1	0	1	0	43	A21	A22	A23	Together	B5	N/A	N/A	N/A	N/A	N/A	N/A	N/A	N/A			
	Innova	2006	>	✓	x	x	Analogue	1	1	1	0	1	0	1	0	12	A8	A7	A6	Together	B3	N/A	N/A	N/A	N/A	N/A	N/A	N/A	N/A	N/A		
	Landcruiser	2007	>	✓	x	x	Analogue	1	1	1	0	1	0	1	0	12	A8	A7	A6	Together	B3	N/A	N/A	N/A	N/A	N/A	N/A	N/A	N/A	N/A		
	Matrix	2003	>	✓	x	x	Analogue	1	1	1	0	1	0	1	0	12	A8	A7	A6	Together	B3	N/A	N/A	N/A	N/A	N/A	N/A	N/A	N/A	N/A		
	Matrix	2003	>	✓	x	x	Analogue	1	1	1	0	1	0	1	0	46	A7/A8	B21/B22	A6/B23	Together	C3/D5	N/A	N/A	N/A	N/A	N/A	N/A	N/A	N/A	N/A		
	Matrix	2003	>	✓	x	x	Analogue	1	1	1	0	1	0	1	0	58	A5/B5	A15/B15	A20/B20	Together	A11/B11	N/A	N/A	N/A	N/A	N/A	N/A	N/A	N/A	N/A	N/A	
	Prado	2007	>	✓	x	x	Analogue	1	1	1	0	1	0	1	0	12	A8	A7	A6	Together	B3	N/A	N/A	N/A	N/A	N/A	N/A	N/A	N/A	N/A	N/A	
	Prado	2006	>	✓	x	x	Analogue	1	1	1	0	1	0	1	0	12	A8	A7	A6	Together	B3	N/A	N/A	N/A	N/A	N/A	N/A	N/A	N/A	N/A	N/A	N/A
	Prado	2001	2017	✓	x	x	Analogue	1	1	1	0	1	0	1	0	12	A8	A7	A6	Together	B3	N/A	N/A	N/A	N/A	N/A	N/A	N/A	N/A	N/A	N/A	
	Prado	2016	>	x	x	x	CAN	1	1	1	1	0	1	0	1	18	N/A	N/A	N/A	N/A	55	44	N/A	N/A	N/A	N/A	N/A	N/A	N/A	N/A		
	Proace	2016	>	x	x	x	CAN	1	1	1	1	0	1	0	1	2	N/A	N/A	N/A	N/A	10	13	N/A	N/A	N/A	N/A	N/A	N/A	N/A	N/A		
	Proace	2016	>	x	x	x	CAN	1	1	1	1	0	1	0	1	2	N/A	N/A	N/A	N/A	10	13	N/A	N/A	N/A	N/A	N/A	N/A	N/A	N/A		
	Proace	2016	>	x	x	x	CAN	1	1	1	1	0	1	0	1	18	N/A	N/A	N/A	N/A	55	44	N/A	N/A	N/A	N/A	N/A	N/A	N/A	N/A		
	Proace Versa	2016	>	x	x	x	CAN	1	1	1	1	0	1	0	1	46	A7/A8	B21/B22	A6/B23	Together	C3/D5	N/A	N/A	N/A	N/A	N/A	N/A	N/A	N/A	N/A		
	RAV4	2001	>	✓	✓	x	Analogue	1	1	1	0	1	0	1	0	58	A5/B5	A15/B15	A20/B20	Together	A11/B11	N/A	N/A	N/A	N/A	N/A	N/A	N/A	N/A	N/A		
	RAV4	2006	>	✓	✓	x	Analogue	1	1	1	0	1	0	1	0	46	A7/A8	B21/B22	A6/B23	Together	C3/D5	N/A	N/A	N/A	N/A	N/A	N/A	N/A	N/A	N/A		
	Rush	2006	>	✓	✓	x	Analogue	1	1	1	0	1	0	1	0	46	A7/A8	B21/B22	A6/B23	Together	C3/D5	N/A	N/A	N/A	N/A	N/A	N/A	N/A	N/A	N/A		
	Rush	2006	>	✓	✓	x	Analogue	1	1	1	0	1	0	1	0	58	A5/B5	A15/B15	A20/B20	Together	A11/B11	N/A	N/A	N/A	N/A	N/A	N/A	N/A	N/A	N/A		
	Sequoia	2003	2013	✓	✓	x	Analogue	1	1	1	0	1	0	1	0	58	A5/B5	A15/B15	A20/B20	Together	A11/B11	N/A	N/A	N/A	N/A	N/A	N/A	N/A	N/A	N/A		
	Sienna	2004	2015	✓	✓	x	Analogue	1	1	1	0	1	0	1	0	12	A8	A7	A6	Together	B3	N/A	N/A	N/A	N/A	N/A	N/A	N/A	N/A	N/A		
	Sienna	2004	2015	✓	✓	x	Analogue	1	1	1	0	1	0	1	0	12	A8	A7	A6	Together	B3	N/A	N/A	N/A	N/A	N/A	N/A	N/A	N/A	N/A		
	Verso 5	2010	2012	✓	✓	x	Analogue	1	1	1	0	1	0	1	0	12	A8	A7	A6	Together	B3	N/A	N/A	N/A	N/A	N/A	N/A	N/A	N/A	N/A		
	Vios	2006	>	✓	✓	x	Analogue	1	1	1	0	1	0	1	0	12	A8	A7	A6	Together	B3	N/A	N/A	N/A	N/A	N/A	N/A	N/A	N/A	N/A		
	Vios	2006	>	✓	✓	x	Analogue	1	1	1	0	1	0	1	0	12	A8	A7	A6	Together	B3	N/A	N/A	N/A	N/A	N/A	N/A	N/A	N/A	N/A		
	Yaris	2001	>	✓	✓	x	Analogue	1	1	1	0	1	0	1	0	46	A7/A8	B21/B22	A6/B23	Together	C3/D5	N/A	N/A	N/A	N/A	N/A	N/A	N/A	N/A	N/A		
	Yaris	2001	>	✓	✓	x	Analogue	1	1	1	0	1	0	1	0	58	A5/B5	A15/B15	A20/B20	Together	A11/B11	N/A	N/A	N/A	N/A	N/A	N/A	N/A	N/A	N/A		
	Tractor	2017	>	x	x	x	CAN	0	1	0	1	0	1	1	1	3	N/A	N/A	N/A	N/A	5	6	N/A	N/A	N/A	N/A	N/A	N/A	N/A			
	Vauxhall	Vivaro	2012	>	✓	x	x	Matrix	0	0	1	0	1	0	1	33	B4	B2	N/A	Together	A8	N/A	N/A	N/A	N/A	N/A	B5	B1	B3			
		Agila	2009	2015	✓	x	x	Analogue	1	0	1	0	1	1	0	10	19	8	20	Together	9	N/A	N/A	N/A	N/A	N/A	N/A	N/A	N/A			
Antara		2006	2010	✓	x	7*	CAN	0	0	1	1	1	1	0	2	N/A	N/A	N/A	N/A	9	10	N/A	N/A	N/A	N/A	N/A	N/A	N/A				
Antara		2010	>	x	x	x	CAN	1	1	0	1	0	1	0	2	N/A	N/A	N/A	N/A	9	10	N/A	N/A	N/A	N/A	N/A	N/A	N/A				
Astra		1998	2004	x	x	x	Analogue	1	1	0	1	0	0	0	3	1	N/A	4	4	Together	S12V*	N/A	N/A	N/A	N/A	N/A	N/A	N/A	N/A			
Astra		2004	2010	✓	x	7*	CAN	0	0	1	1	1	1	0	2	N/A	N/A	N/A	N/A	9	10	N/A	N/A	N/A	N/A	N/A	N/A	N/A				
Astra		2010	>	x	x	x	CAN (SW)	0	0	0	0	0	1	1	9	N/A	N/A	N/A	N/A	4	4	Together	28	N/A	N/A	N/A	N/A	N/A				
Astra		2000	2004	x	x	x	Analogue	1	1	0	1	0	0	0	3	1	N/A	4	4	Together	S12V*	N/A	N/A	N/A	N/A	N/A	N/A	N/A	N/A			
Corsa		2004	2009	✓	✓	x	7*	CAN	0	0	1	1	1	1	0	2	N/A	N/A	N/A	9	10	N/A	N/A	N/A	N/A	N/A	N/A	N/A	N/A			
Corsa		2009	>	✓	✓	x	7*	CAN	0	0	1	1	1	1	0	2	N/A	N/A	N/A	N/A	9	10	N/A	N/A	N/A	N/A	N/A	N/A	N/A			
Corsa		2008	2013	x	x	x	CAN (SW)	0	0	0	0	0	1	1	0	9	N/A	N/A	N/A	4	4	Together	28	N/A	N/A	N/A	N/A	N/A	N/A			
Insignia		2003	2005	x	x	x	Analogue	1	1	0	1	1	1	0	3	1	N/A	4	4	Together	S12V*	N/A	N/A	N/A	N/A	N/A	N/A	N/A	N/A			
Meriva		2005	2010	✓	✓	x	7*	CAN	0	0	1	1	1	1	0	2	N/A	N/A	N/A	N/A	9	10	N/A	N/A	N/A	N/A	N/A	N/A	N/A			
Meriva		2010	>	✓	✓	x	CAN (SW)	0	0	0	0	1	1	0	9	N/A	N/A	N/A	N/A	4	4	Together	28	N/A	N/A	N/A	N/A	N/A	N/A			
Meriva		2010	>	✓	✓	x	CAN (SW)	0	0	0	0	0	1	1	9	N/A	N/A	N/A	N/A	4	4	Together	28	N/A	N/A	N/A	N/A	N/A	N/A			
Mokka		2012	>	✓	✓	x	Matrix	0	0	1	0	1	0	1	33	B4	B2	N/A	Together	A8	N/A	N/A	N/A	N/A	N/A	B5	B1	B3				
Movano		2013	>	✓	✓	x	Analogue	1	1	0	1	0	0	0	3	1	N/A	4	4	Together	S12V*	N/A	N/A	N/A	N/A	N/A	N/A	N/A	N/A			
Omega		2000	2003	x	x	x	Analogue	1	1	0	1	0	0	0	3	1	N/A	N/A	N/A	4	4	Together	N/A	N/A	N/A	N/A	N/A	N/A	N/A			
Signum		2005	2008	✓	✓	x	CAN	0	0	1	1	1	1	0	2	N/A	N/A	N/A	N/A	9	10	N/A	N/A	N/A	N/A	N/A	N/A	N/A				
Tigra		2004	2009	✓	✓	x	7*	CAN	0	0	1	1	1	1	0	2	N/A	N/A	N/A	N/A	9	10	N/A	N/A	N/A	N/A	N/A	N/A				
Vectra		1998	2004	x	x	x	Analogue	1	1	0	1	0	0	0	3	1	N/A	4	4	Together	S12V*	N/A	N/A	N/A	N/A	N/A	N/A	N/A	N/A			
Vectra		2004	2008	✓	✓	x	7*	CAN	0	0	1	1	1	1	0	3	1	N/A	4	4	Together	S12V*	N/A	N/A	N/A	N/A	N/A	N/A	N/A			
Vivaro		2002	2006	x	x	x	Analogue	1	1	0	1	1	1	1	0	3	1	N/A	4	4	Together	S12V*	N/A	N/A	N/A	N/A	N/A	N/A	N/A			
Vivaro		2011	2013	✓	✓	x	6*	CAN	0	0	0	1	1	1	0	1	N/A	N/A	N/A	N/A	17	30	N/A	N/A	N/A	N/A	N/A	N/A	N/A			
Vivaro		2015	>	✓	✓	x	Matrix	0	0	1	0	1	0	0	1	33	B4	B2	N/A	Together	A8	N/A	N/A	N/A	N/A	N/A	B5	B1	B3			
Zafira		1999	2005	x	x	x	Analogue																									

Man.	Model	Year From	Year To	Phone Button Support	Voice Assistant Support	Menu	Platform	Dipswitch Setting (0 - Off / 1 - On)								Diagram No.	IN6	IN7	Ara. GND	IN2	IN3	IN5	IN1	IN4	IN8	IN9	IN13	IN14	IN15	IN10
								1	2	3	4	5	6	7	8															
	Amarok	2010	>	✓	x	x	CAN (FT)	1	1	0	1	1	0	1	0	2	N/A	N/A	N/A	9	10	N/A	N/A	N/A	N/A	N/A	N/A	N/A		
	Amarok	2010	>	✓	x	x	CAN (HS)	1	1	0	1	1	0	1	0	2	N/A	N/A	N/A	9	10	N/A	N/A	N/A	N/A	N/A	N/A	N/A		
	Beetle	2015	>	✓	x	x	CAN (FT)	1	1	0	1	1	0	1	0	5	N/A	N/A	N/A	22	28	N/A	N/A	N/A	N/A	N/A	N/A	N/A		
	Caddy	2015	>	✓	x	x	CAN (FT)	1	1	0	1	1	0	1	0	5	N/A	N/A	N/A	22	28	N/A	N/A	N/A	N/A	N/A	N/A	N/A		
	CC	2009	2013	✓	x	x	CAN (FT)	1	1	0	1	1	0	1	0	2	N/A	N/A	N/A	9	10	N/A	N/A	N/A	N/A	N/A	N/A	N/A		
	Crafter	2006	>	✓	x	x	CAN	1	0	1	1	1	1	0	3	N/A	N/A	N/A	3	8	N/A	N/A	N/A	N/A	N/A	N/A	N/A	N/A		
	Crafter	2006	>	✓	x	x	CAN	1	0	1	1	1	1	0	3	N/A	N/A	N/A	3	8	N/A	N/A	N/A	N/A	N/A	N/A	N/A	N/A		
	EOS	2006	2015	✓	x	x	CAN (FT)	1	1	0	1	1	0	1	0	2	N/A	N/A	N/A	9	10	N/A	N/A	N/A	N/A	N/A	N/A	N/A		
	Fusca	2005	2011	✓	x	x	CAN (FT)	1	1	0	1	1	0	1	0	2	N/A	N/A	N/A	9	10	N/A	N/A	N/A	N/A	N/A	N/A	N/A		
	Fusca	2005	>	✓	x	x	CAN (HS)	1	1	0	1	1	0	1	0	2	N/A	N/A	N/A	9	10	N/A	N/A	N/A	N/A	N/A	N/A	N/A		
	Gol	2012	>	✓	x	x	CAN (HS)	0	0	1	0	0	1	0	2	N/A	N/A	N/A	9	10	N/A	N/A	N/A	N/A	N/A	N/A	N/A	N/A		
	Gol	2012	>	✓	x	x	CAN (HS)	0	0	1	0	0	1	0	2	N/A	N/A	N/A	9	10	N/A	N/A	N/A	N/A	N/A	N/A	N/A	N/A		
	Gol	2005	2012	✓	x	x	IR	0	0	0	0	1	0	1	1	1	N/A	N/A	N/A	Together	2	N/A	N/A	N/A	N/A	N/A	N/A	N/A		
	Golf 6	2003	2013	x	x	x	CAN (FT)	1	1	0	0	0	1	1	0	2	N/A	N/A	N/A	9	10	N/A	N/A	N/A	N/A	N/A	N/A	N/A		
	Jetta	2005	2015	✓	x	x	CAN (FT)	1	1	0	1	1	0	1	0	2	N/A	N/A	N/A	9	10	N/A	N/A	N/A	N/A	N/A	N/A	N/A		
	Jetta	2005	2015	✓	x	x	CAN (HS)	1	1	0	1	1	0	1	0	2	N/A	N/A	N/A	9	10	N/A	N/A	N/A	N/A	N/A	N/A	N/A		
	Jetta	1999	2015	✓	x	x	LIN	0	0	0	0	1	1	0	1	1	N/A	N/A	N/A	Together	2	N/A	N/A	N/A	N/A	N/A	N/A	N/A		
	Jetta	2015	>	✓	x	x	CAN (FT)	1	1	0	1	1	0	1	0	5	N/A	N/A	N/A	22	28	N/A	N/A	N/A	N/A	N/A	N/A	N/A		
	Magotan	2005	2011	✓	x	x	CAN (FT)	1	1	0	1	1	0	1	0	2	N/A	N/A	N/A	9	10	N/A	N/A	N/A	N/A	N/A	N/A	N/A		
	Magotan	2005	>	✓	x	x	CAN (HS)	1	1	0	1	1	0	1	0	2	N/A	N/A	N/A	9	10	N/A	N/A	N/A	N/A	N/A	N/A	N/A		
	Multivan	2003	2009	✓	x	x	CAN (FT)	1	1	0	0	0	1	1	0	2	N/A	N/A	N/A	9	10	N/A	N/A	N/A	N/A	N/A	N/A	N/A		
	Passat	2005	2015	✓	x	x	CAN (FT)	1	1	0	1	1	0	1	0	2	N/A	N/A	N/A	9	10	N/A	N/A	N/A	N/A	N/A	N/A	N/A		
	Passat	2005	2015	✓	x	x	CAN (HS)	1	1	0	1	1	0	1	0	2	N/A	N/A	N/A	9	10	N/A	N/A	N/A	N/A	N/A	N/A	N/A		
	Passat	2005	2015	✓	x	x	CAN (FT)	1	1	0	1	1	0	1	0	2	N/A	N/A	N/A	9	10	N/A	N/A	N/A	N/A	N/A	N/A	N/A		
	Polo	2005	2014	✓	x	x	CAN (FT)	1	1	0	1	1	0	1	0	2	N/A	N/A	N/A	9	10	N/A	N/A	N/A	N/A	N/A	N/A	N/A		
	Polo	2005	2014	✓	x	x	CAN (HS)	1	1	0	1	1	0	1	0	2	N/A	N/A	N/A	9	10	N/A	N/A	N/A	N/A	N/A	N/A	N/A		
	R32	2007	2008	✓	x	x	CAN (FT)	1	1	0	1	1	0	1	0	2	N/A	N/A	N/A	9	10	N/A	N/A	N/A	N/A	N/A	N/A	N/A		
	Rabbit	2006	2008	✓	x	x	CAN (FT)	1	1	0	1	1	0	1	0	2	N/A	N/A	N/A	9	10	N/A	N/A	N/A	N/A	N/A	N/A	N/A		
	Sagitar	2005	2011	✓	x	x	CAN (FT)	1	1	0	1	1	0	1	0	2	N/A	N/A	N/A	9	10	N/A	N/A	N/A	N/A	N/A	N/A	N/A		
	Sagitar	2005	>	✓	x	x	CAN (HS)	1	1	0	1	1	0	1	0	2	N/A	N/A	N/A	9	10	N/A	N/A	N/A	N/A	N/A	N/A	N/A		
	Scirocco	2008	2015	✓	x	x	CAN (FT)	1	1	0	1	1	0	1	0	2	N/A	N/A	N/A	9	10	N/A	N/A	N/A	N/A	N/A	N/A	N/A	N/A	
	Scirocco	2008	2015	✓	x	x	CAN (HS)	1	1	0	1	1	0	1	0	2	N/A	N/A	N/A	9	10	N/A	N/A	N/A	N/A	N/A	N/A	N/A	N/A	
	Scirocco	2008	2015	✓	x	x	CAN (FT)	1	1	0	1	1	0	1	0	5	N/A	N/A	N/A	22	28	N/A	N/A	N/A	N/A	N/A	N/A	N/A	N/A	
	Sharan	2015	>	✓	x	x	CAN (FT)	1	1	0	1	1	0	1	0	5	N/A	N/A	N/A	22	28	N/A	N/A	N/A	N/A	N/A	N/A	N/A	N/A	
	Suran	2009	>	✓	x	x	CAN (FT)	1	1	0	1	1	0	1	0	2	N/A	N/A	N/A	9	10	N/A	N/A	N/A	N/A	N/A	N/A	N/A	N/A	
	Suran	2009	>	✓	x	x	CAN (HS)	1	1	0	1	1	0	1	0	2	N/A	N/A	N/A	9	10	N/A	N/A	N/A	N/A	N/A	N/A	N/A	N/A	
	T-6	2015	>	✓	x	x	CAN (FT)	1	1	0	1	1	0	1	0	5	N/A	N/A	N/A	22	28	N/A	N/A	N/A	N/A	N/A	N/A	N/A	N/A	
	Tiguan	2007	2015	✓	x	x	CAN (FT)	1	1	0	1	1	0	1	0	2	N/A	N/A	N/A	9	10	N/A	N/A	N/A	N/A	N/A	N/A	N/A	N/A	
	Tiguan	2008	2011	✓	x	x	CAN (HS)	1	1	0	1	1	0	1	0	2	N/A	N/A	N/A	9	10	N/A	N/A	N/A	N/A	N/A	N/A	N/A	N/A	
	Tiguan	2015	>	✓	x	x	CAN (FT)	1	1	0	1	1	0	1	0	5	N/A	N/A	N/A	22	28	N/A	N/A	N/A	N/A	N/A	N/A	N/A	N/A	
	Tiguan	2015	>	✓	x	x	CAN (HS)	1	1	0	1	1	0	1	0	2	N/A	N/A	N/A	9	10	N/A	N/A	N/A	N/A	N/A	N/A	N/A	N/A	
	Touareg	2004	2010	✓	x	x	CAN (FT)	1	1	0	1	1	0	1	0	2	N/A	N/A	N/A	9	10	N/A	N/A	N/A	N/A	N/A	N/A	N/A	N/A	
	Touareg	2003	2010	x	x	x	CAN (FT)	1	1	0	0	0	1	1	0	2	N/A	N/A	N/A	9	10	N/A	N/A	N/A	N/A	N/A	N/A	N/A	N/A	
	Touran	2003	2015	✓	x	x	CAN (FT)	1	1	0	1	1	0	1	0	2	N/A	N/A	N/A	9	10	N/A	N/A	N/A	N/A	N/A	N/A	N/A	N/A	
	Touran	2003	2015	✓	x	x	CAN (FT)	1	1	0	1	1	0	1	0	2	N/A	N/A	N/A	9	10	N/A	N/A	N/A	N/A	N/A	N/A	N/A	N/A	
	Transporter	2003	2015	✓	x	x	CAN (FT)	1	1	0	1	1	0	1	0	2	N/A	N/A	N/A	9	10	N/A	N/A	N/A	N/A	N/A	N/A	N/A	N/A	
	Transporter	2003	2015	✓	x	x	CAN (HS)	1	1	0	1	1	0	1	0	2	N/A	N/A	N/A	9	10	N/A	N/A	N/A	N/A	N/A	N/A	N/A	N/A	
	Vento	2005	2011	✓	x	x	CAN (FT)	1	1	0	1	1	0	1	0	2	N/A	N/A	N/A	9	10	N/A	N/A	N/A	N/A	N/A	N/A	N/A	N/A	
	Vento	2005	>	✓	x	x	CAN (HS)	1	1	0	1	1	0	1	0	2	N/A	N/A	N/A	9	10	N/A	N/A	N/A	N/A	N/A	N/A	N/A	N/A	

Volkswagen

Config. 1 (1*)

To Enter Menu Mode

- Press and hold 'Mute' button for 2 seconds (Citroen vehicles) **or** press 'Track +' and 'Track -' buttons in unison (Peugeot vehicles)

To Navigate Through Settings

- Use 'Track +' and 'Track -' to navigate through settings and select a menu with 'Volume +' (Citroen/Peugeot vehicles).
- If the above step doesn't work, hold the 'Source' button (Peugeot vehicles) or 'Mute' button (Citroen vehicles) for 3 seconds. After 3 seconds, the display will return to radio mode.
- Now the scroll wheel can be used to adjust the selected menu item

NB: Once power has been removed from the interface, it will default back to its original settings

Config. 2 (2*)

To Adjust Clock

- Press & hold 'SET' button for 2 seconds
- Press 'Up' to change the hour
- Press 'Down' to change the minute
- Press and hold 'SET' button to exit or wait for 10 seconds

To Navigate Trip Computer

- Press the 'Right Arrow' button repeatedly until the clock in the vehicle display is highlighted
- Use the 'Up' and 'Down' buttons to navigate the trip computer

To Reset Trip Computer

- Navigate to the trip computer setting you wish to reset
- Press and hold 'SET' until the reading clears. The display should now show: '_ _ _'

Config. 3 (3*)

To Adjust Fader

- Press and hold 'MODE' button for 2 seconds
- The vehicle screen will now display 'SETTINGS'
- Press the 'Track -' button until the display shows 'FADER ADJUST'
- Press the 'MODE' button to select
- Adjust the fader with 'Track +' and 'Track -' buttons
- Press 'MODE' button to exit or wait for 10 seconds

To Adjust Clock

- Press and hold 'MODE' button for 2 seconds
- The vehicle screen will now display 'SETTINGS'
- Press 'MODE' button to select. The screen will now display 'INFO/CLOCK'
- Press and hold 'Track -' to enter time adjust mode
- Press 'Track +' to adjust the time digit
- Press 'Track -' to move onto the next time digit
- Press 'MODE' button to exit or wait for 10 seconds

To Adjust Trip Computer

- Press and hold 'MODE' button for 2 seconds
- The vehicle screen will now display 'SETTINGS'
- Press 'MODE' button to select. The screen will now display 'INFO/CLOCK'
- Press 'Track +' to access trip information
- Press 'Track +' repeatedly to scroll through trip information options
- Press 'Track -' to return to clock display
- Press 'MODE' button to exit or wait for 10 seconds

Config. 4 (4*)

To Adjust Clock

- Press and hold 'ENTER' button for 8 seconds
- Use 'Track -' to adjust hours
- Use 'Track +' to adjust minutes
- Press 'ENTER' button to set the time or press and hold 'ENTER' button to exit the menu without saving changes

Config. 5 (5*)

To Enter Menu

Hold 'Hang Up'

To Change Minutes

Press 'Track +'

To Change Minutes

Press 'Track -'

Config. 6 (6*)

To Adjust Clock

- Press and hold 'Source' button on the steering wheel until the time displayed on the dashboard flashes '00:00' for 1 second. This signifies that clock setting mode has been entered.
- Use 'Volume +' to adjust hours and 'Volume -' to adjust minutes
- Once the correct time has been set, wait for 5 seconds and the display will flash 00:00 for 1 second to signify that clock setting mode has been exited.

Config. 7 (7*)

To Access System Settings

- Press and hold 'Source' button for 2 seconds
- Use 'Volume +' and 'Volume -' to scroll through settings (ie. Lang, IGN Logic, Clock Sync)
- Press 'Track +' and 'Track -' to change settings
- Press 'Source' to exit

d. Diagram Chart

Important: Please note, connectors are shown from the terminal side and *not* the wire side

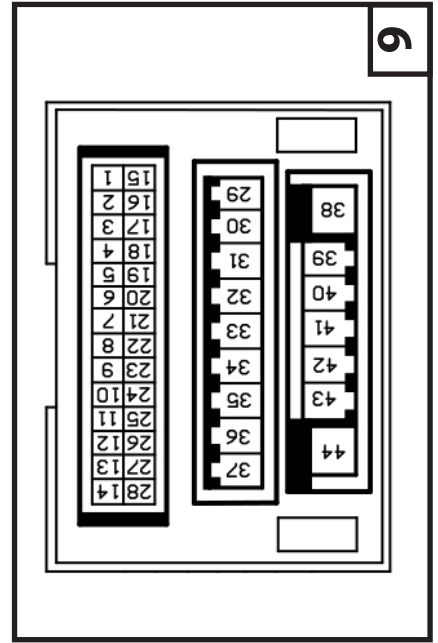
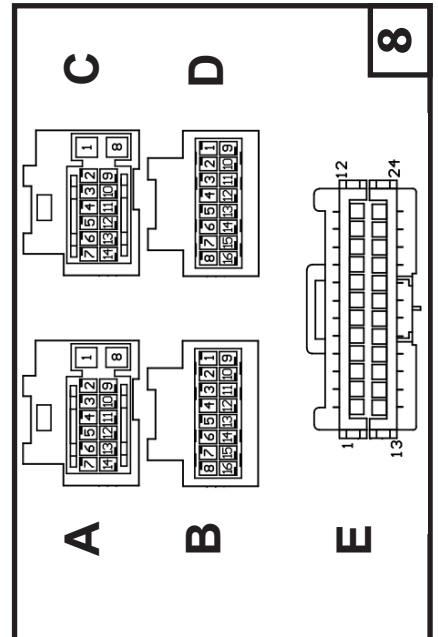
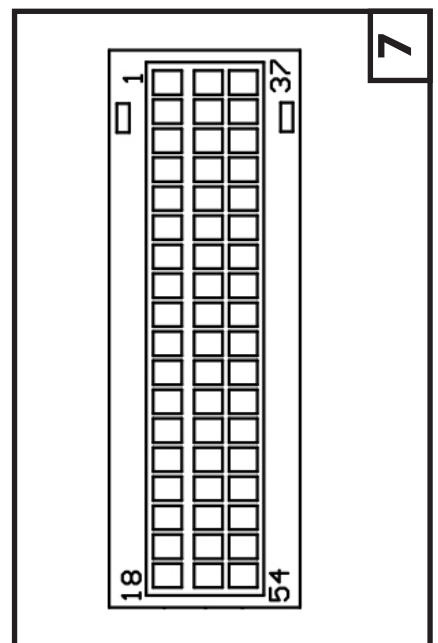
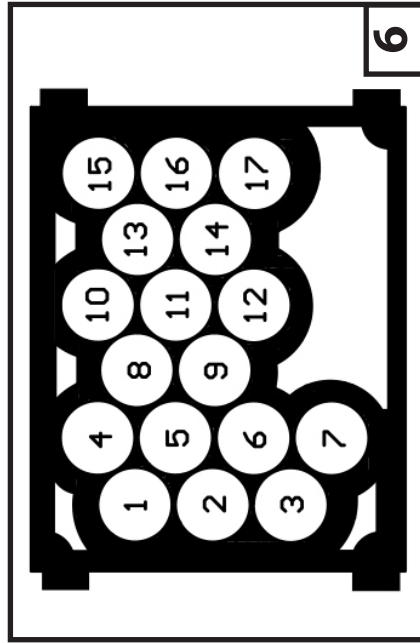
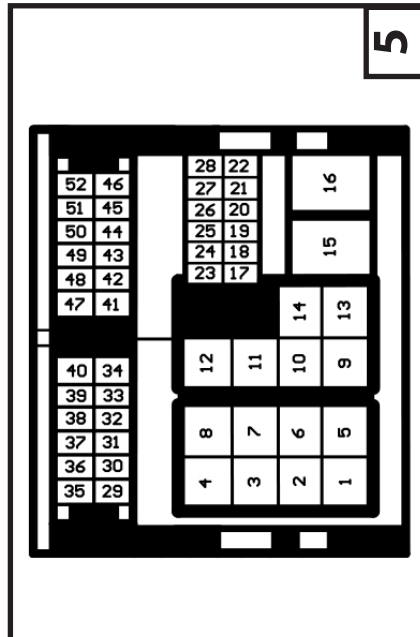
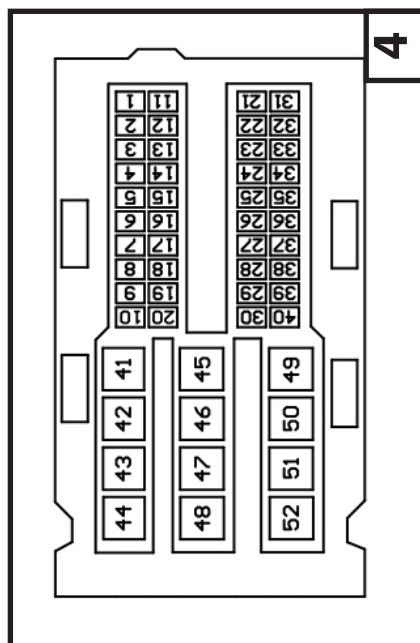
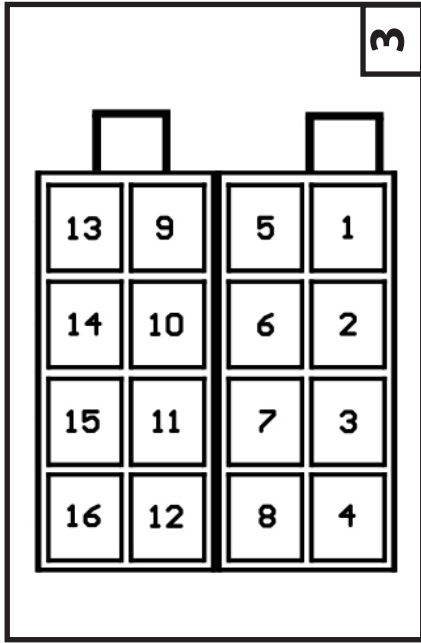
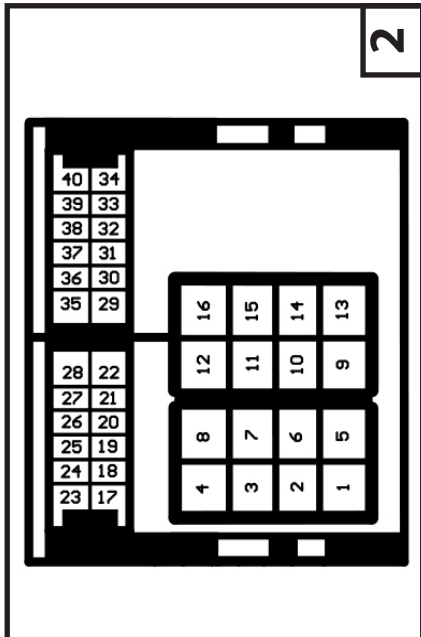
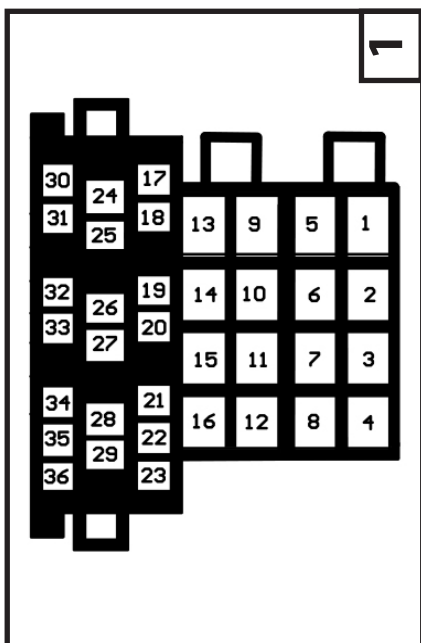

Important: Please note, connectors are shown from the terminal side and **not** the wire side

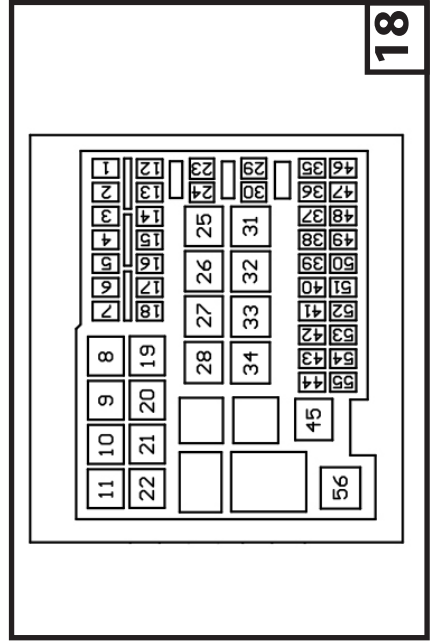
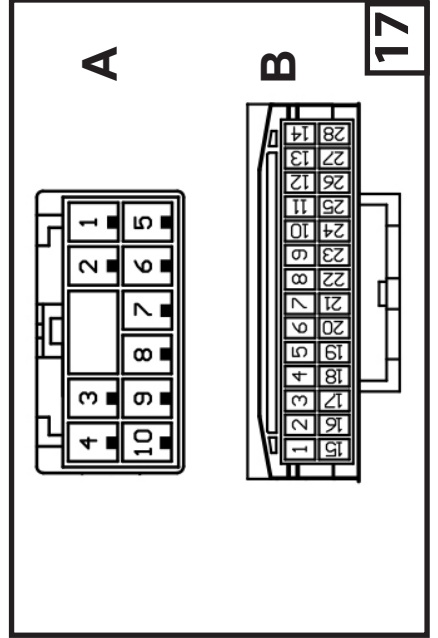
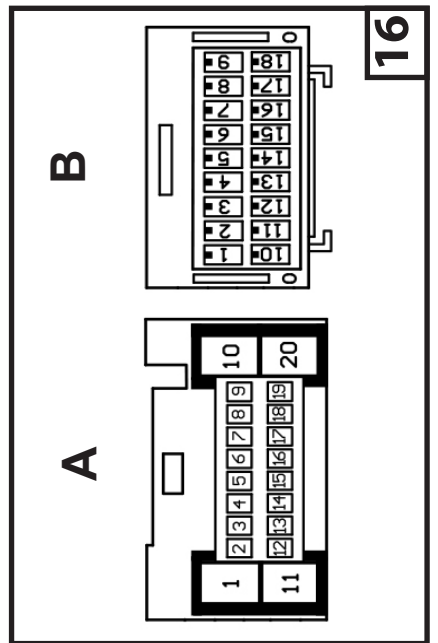
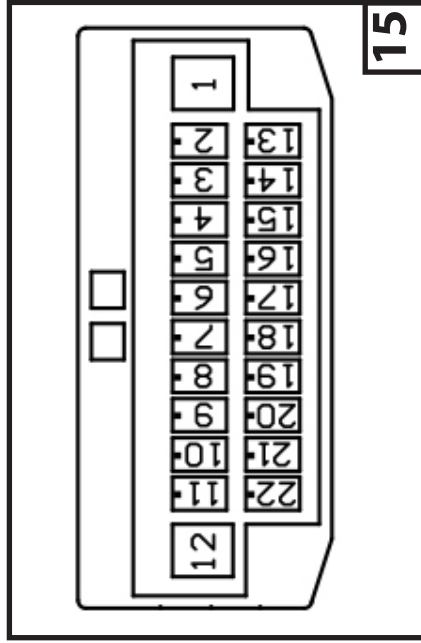
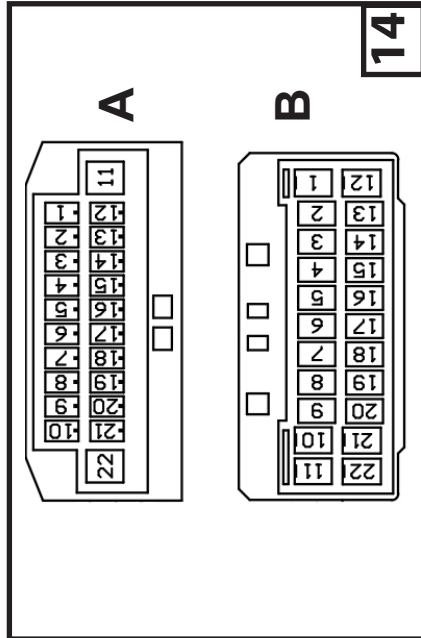
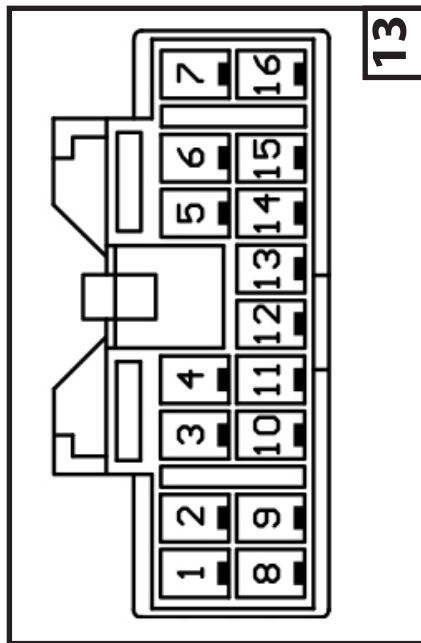
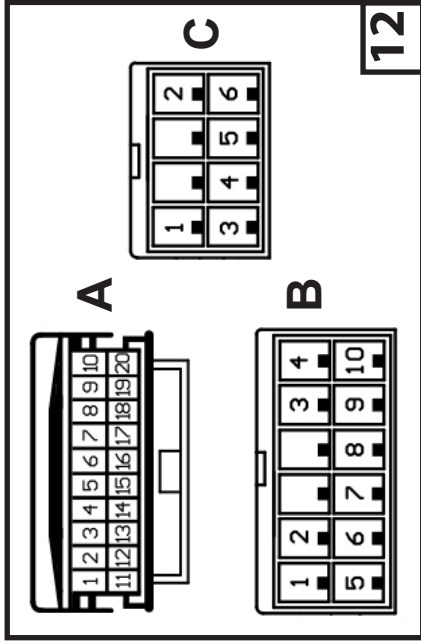
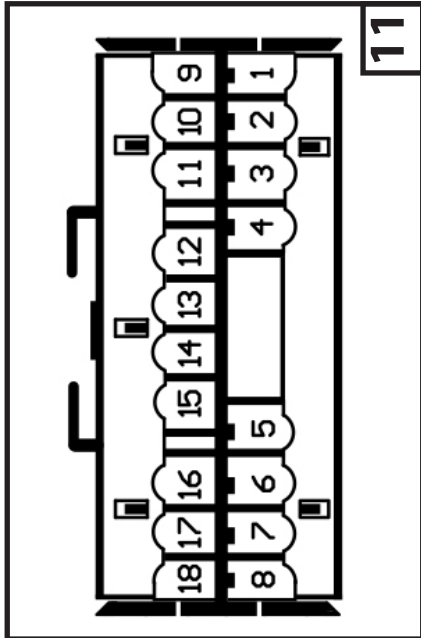
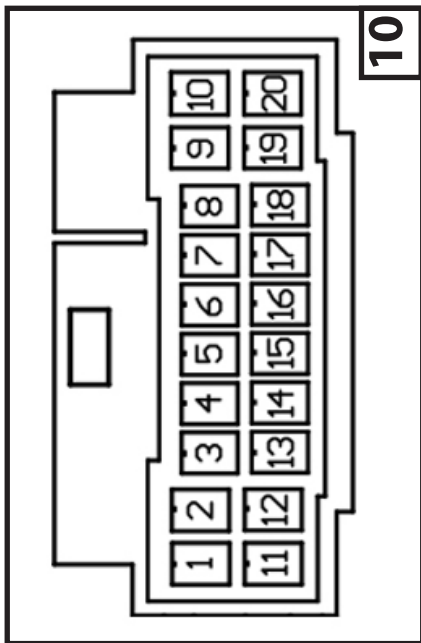

Important: Please note, connectors are shown from the terminal side and **not** the wire side

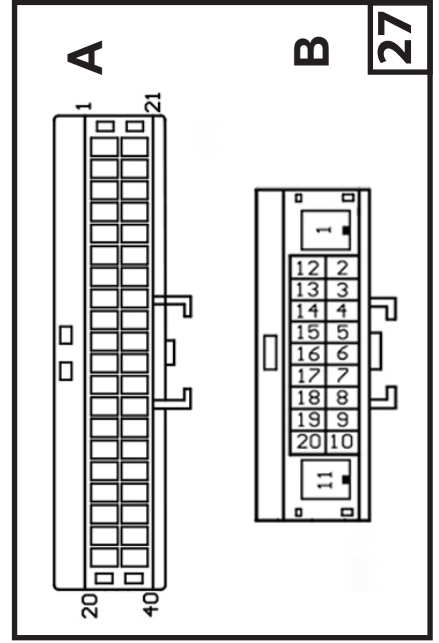
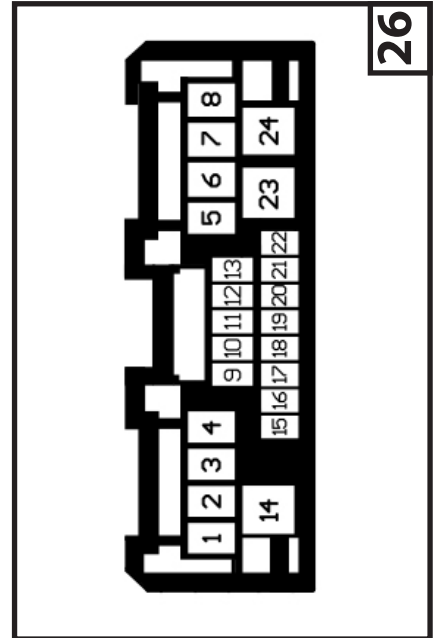
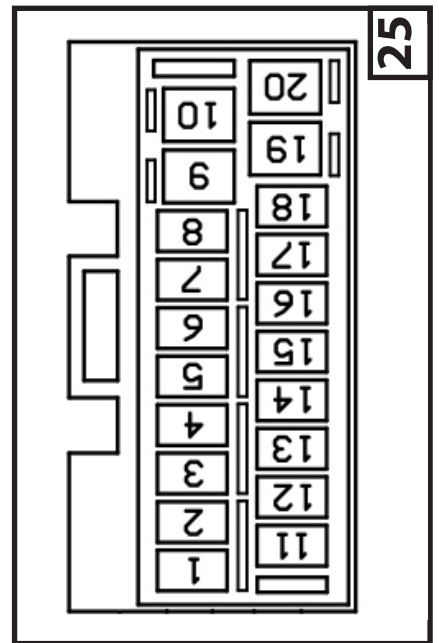
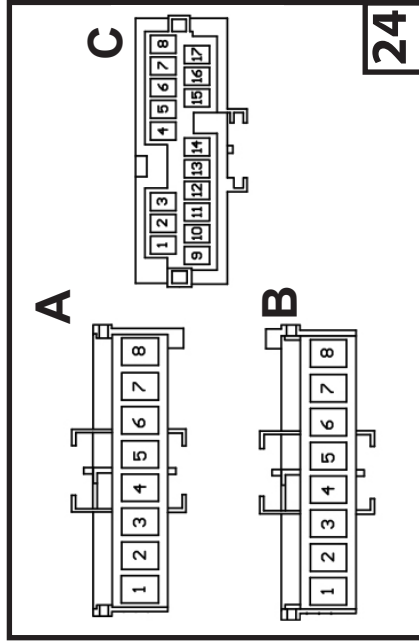
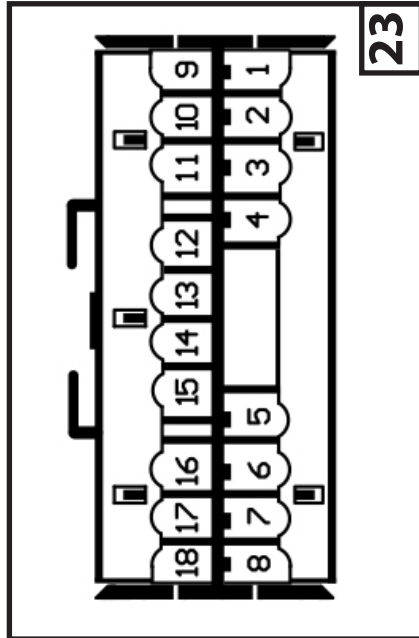
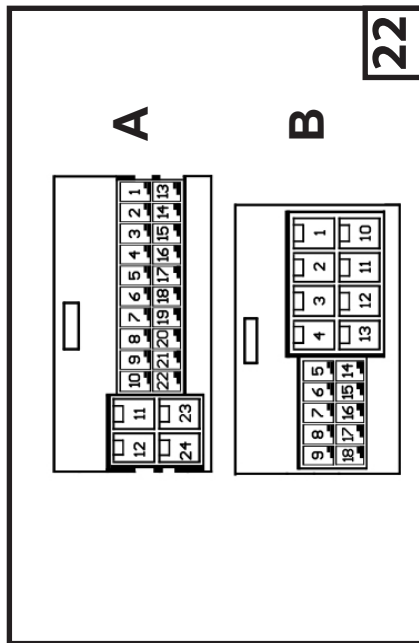
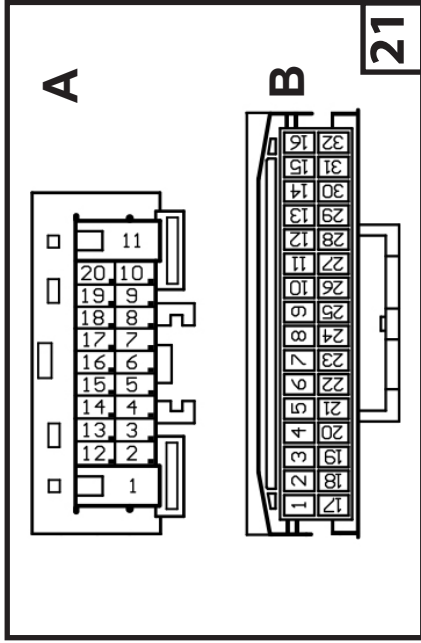
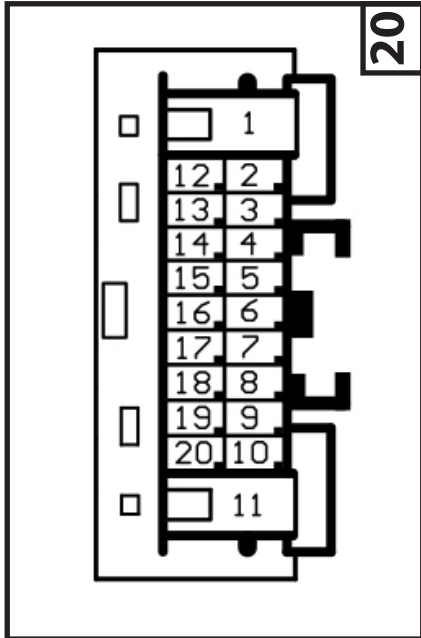
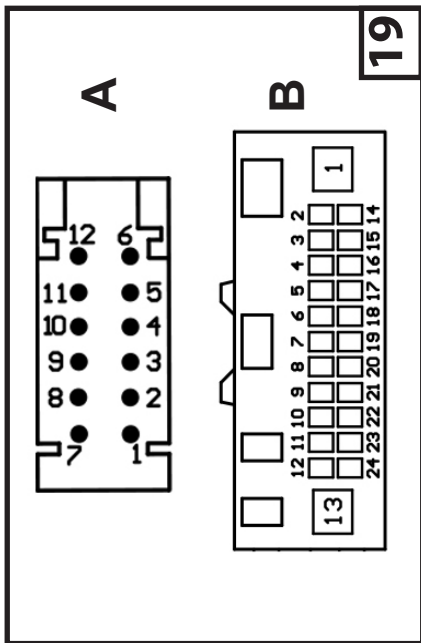

Important: Please note, connectors are shown from the terminal side and *not* the wire side

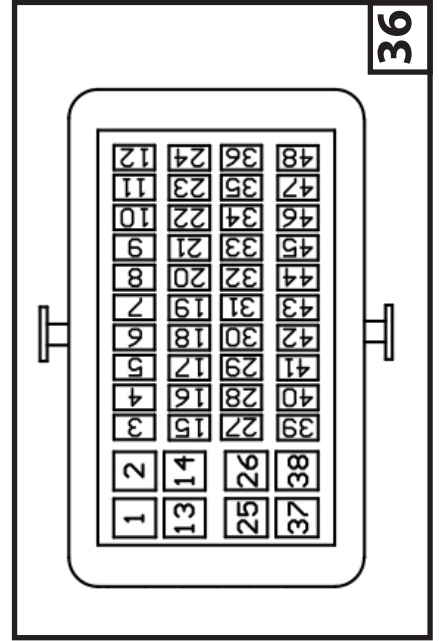
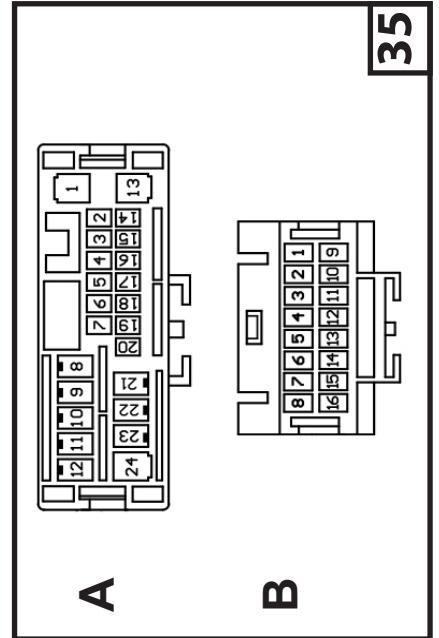
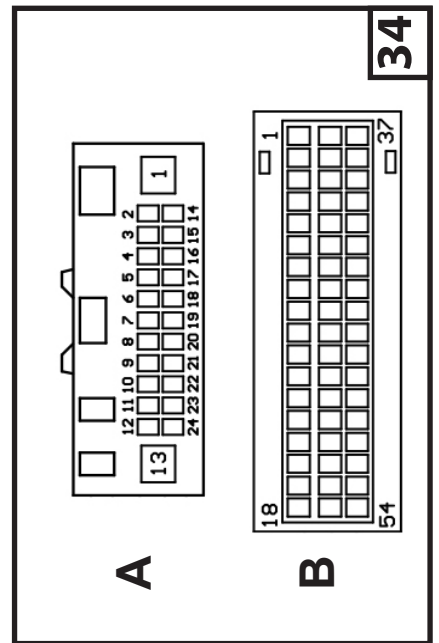
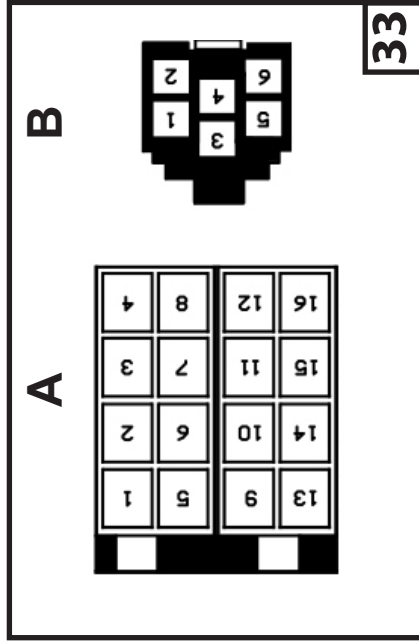
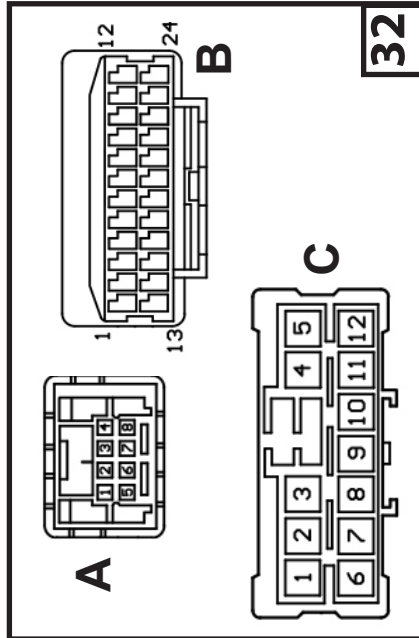
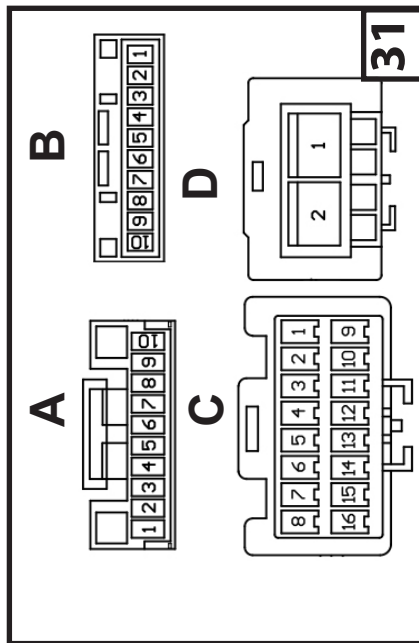
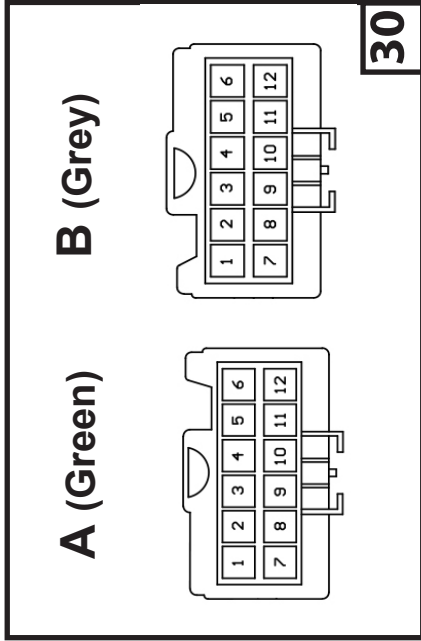
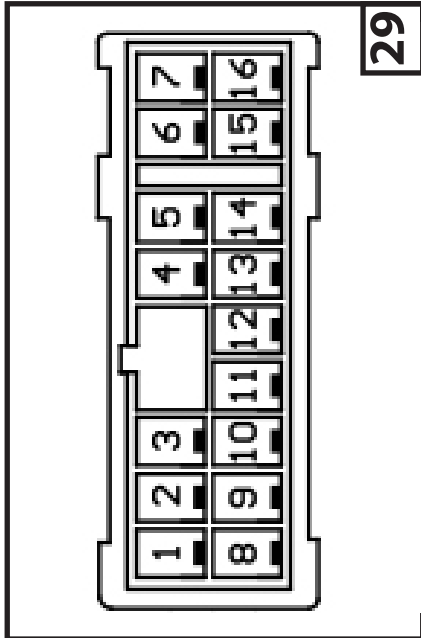
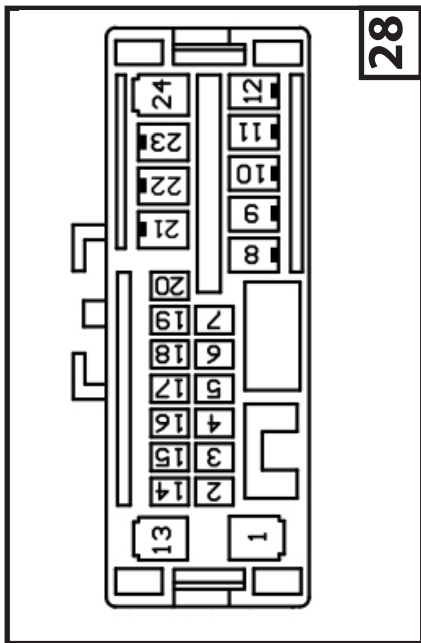

Important: Please note, connectors are shown from the terminal side and *not* the wire side

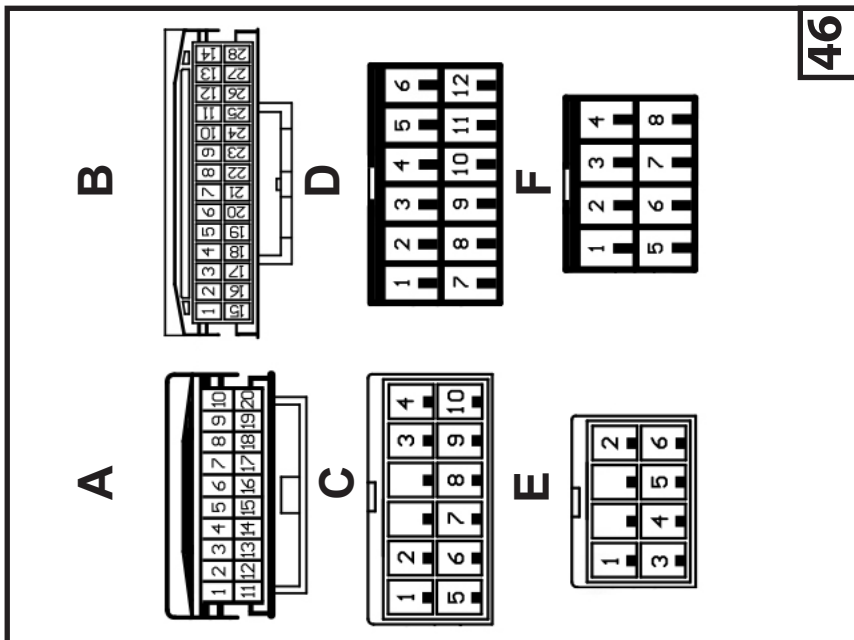

46

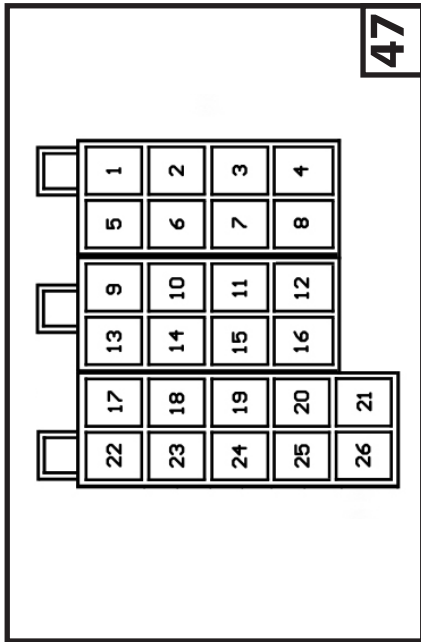

47

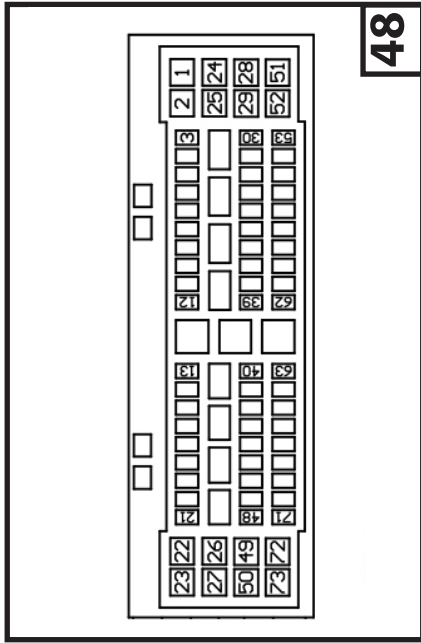

48

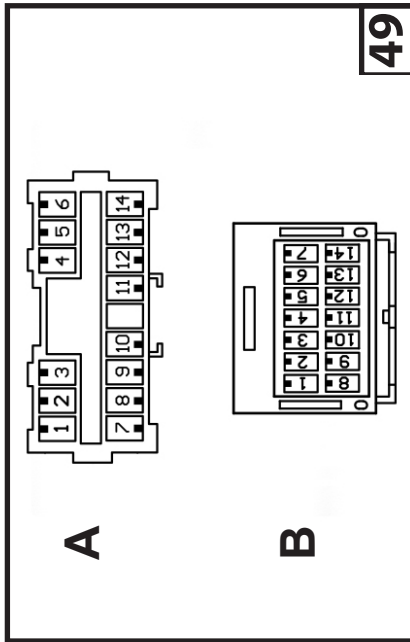

49

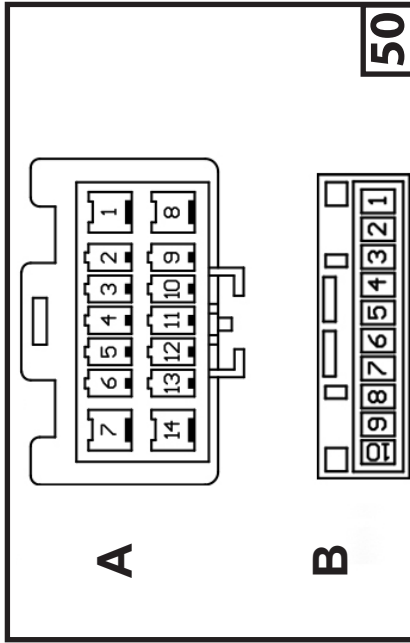

50

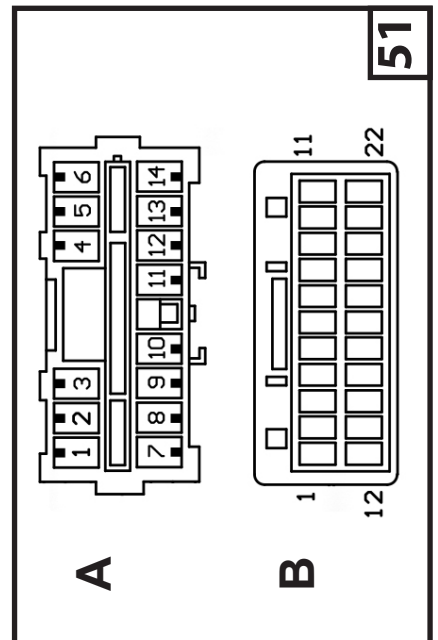

51

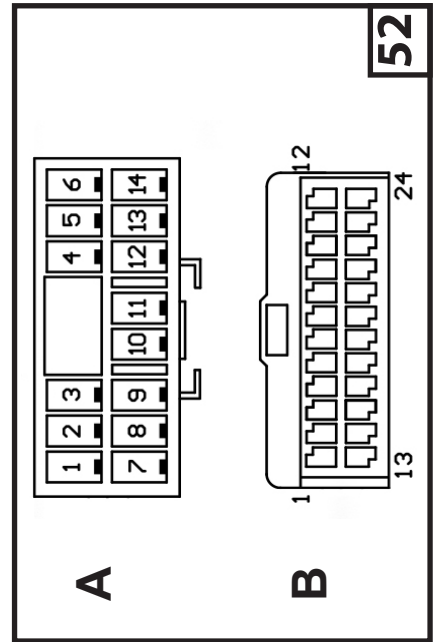

52

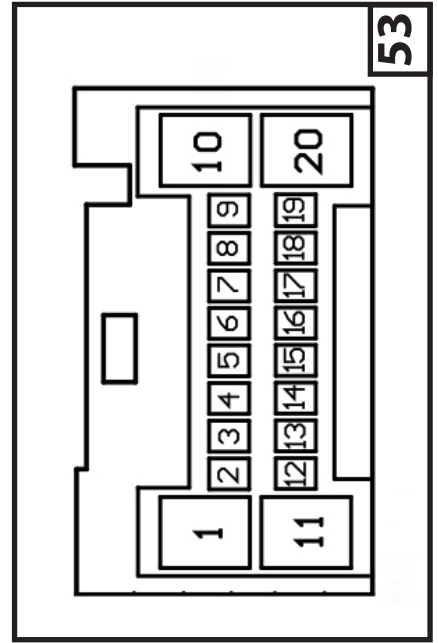

53

Important: Please note, connectors are shown from the terminal side and *not* the wire side

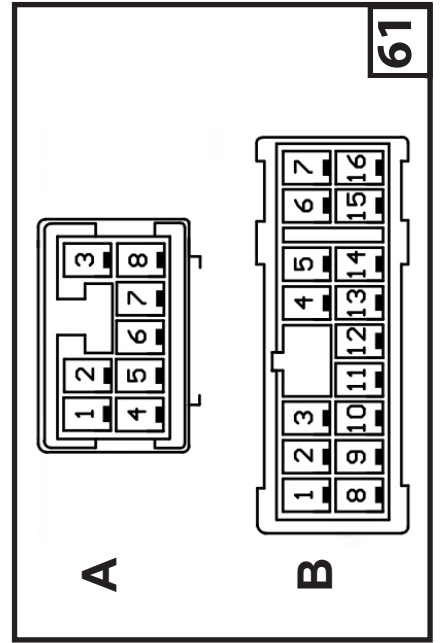
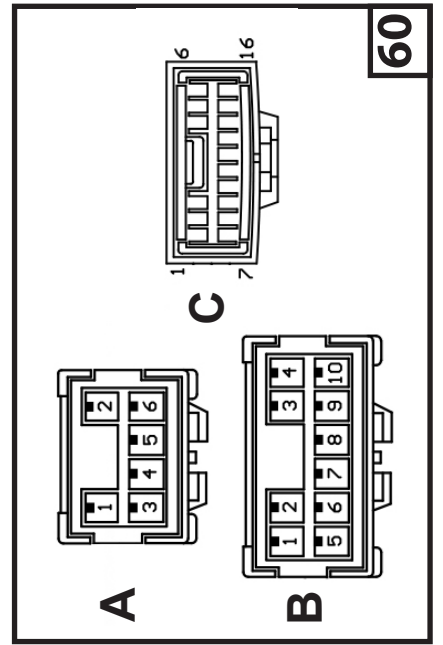
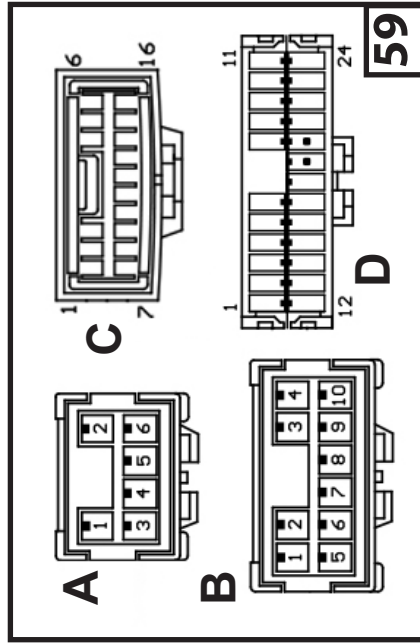
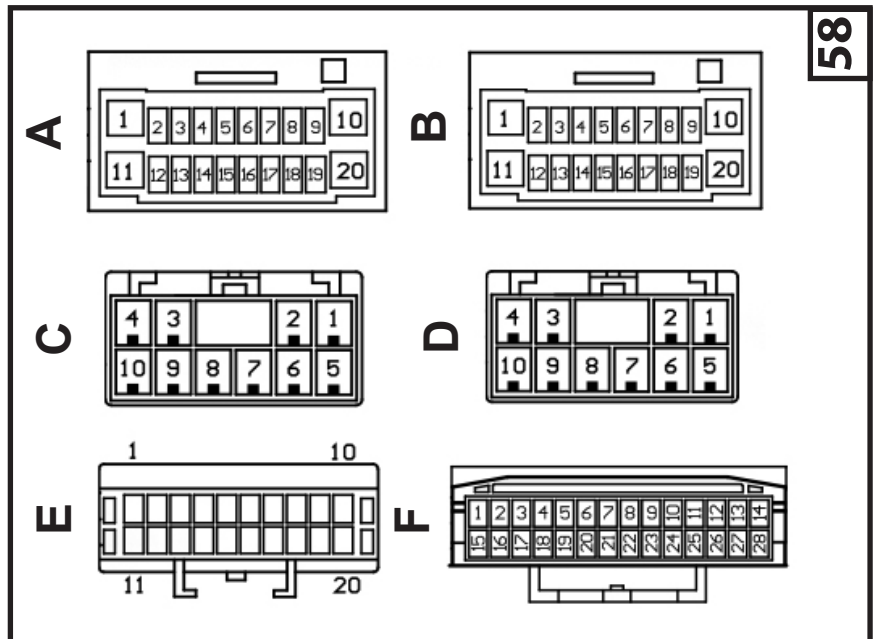
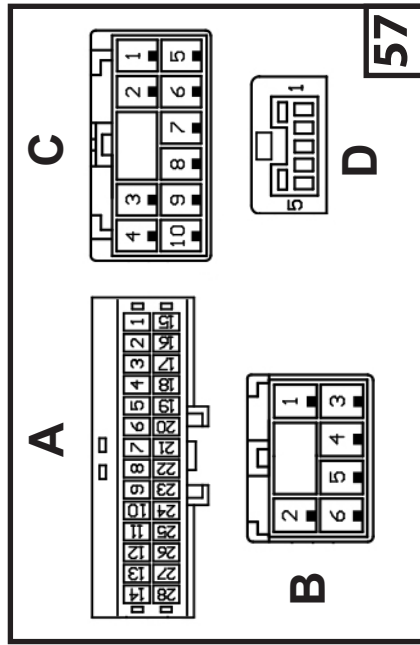
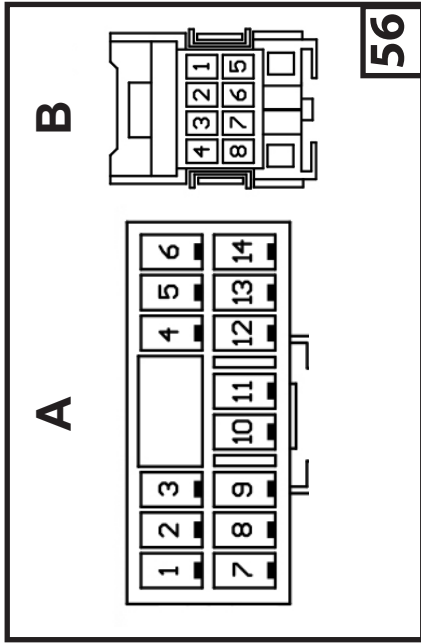
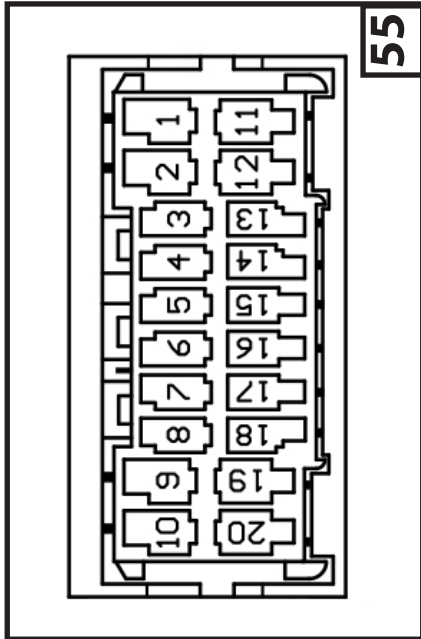
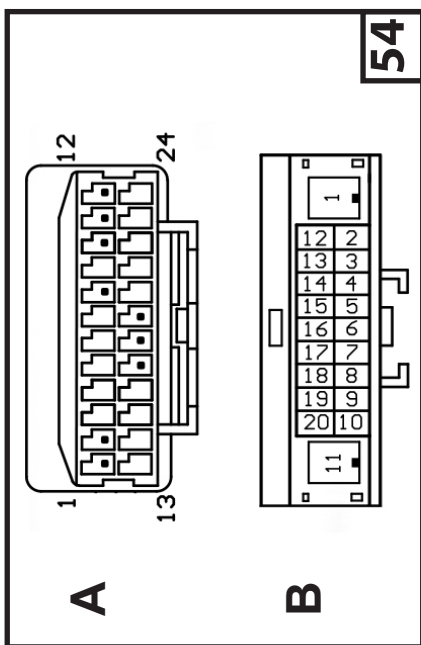

Important: Please note, connectors are shown from the terminal side and *not* the wire side

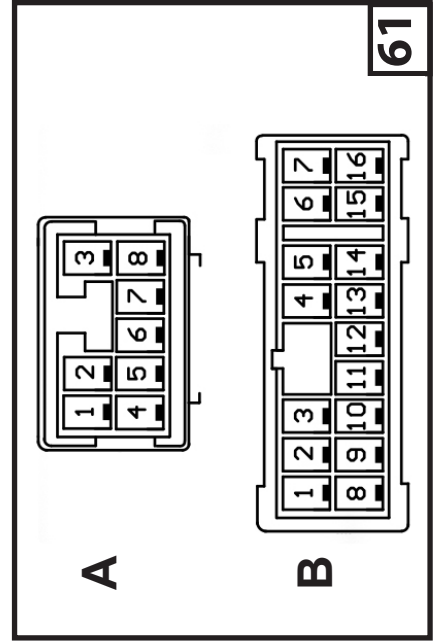
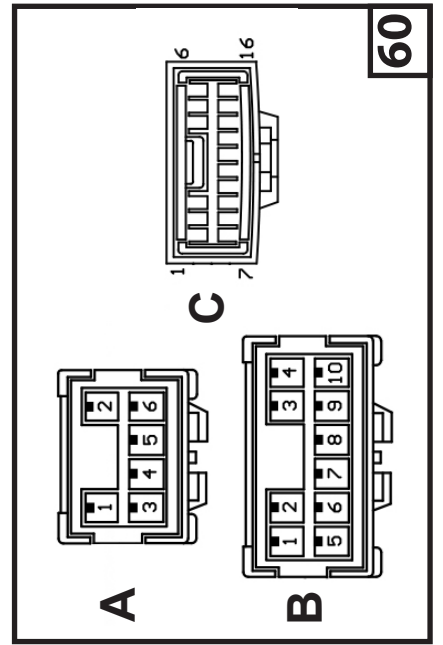
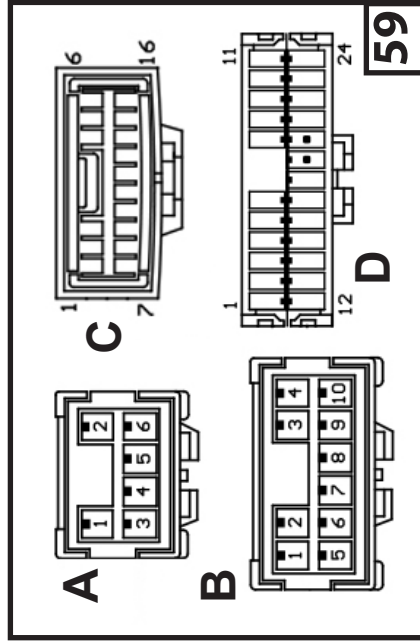
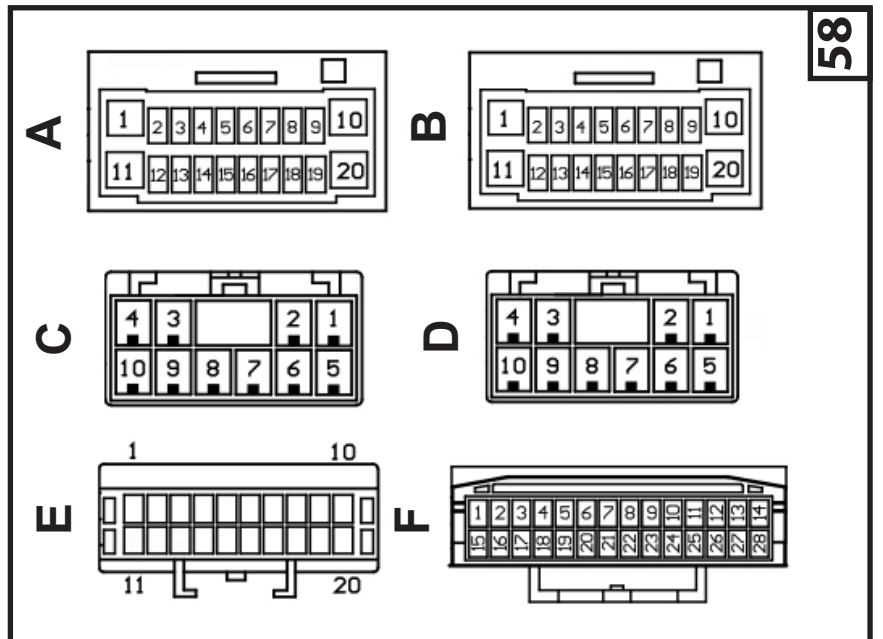
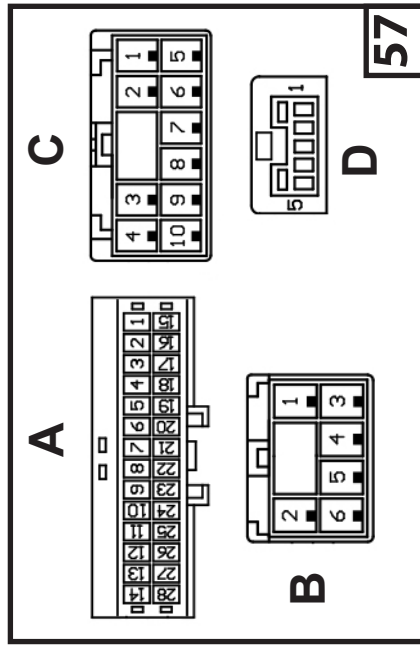
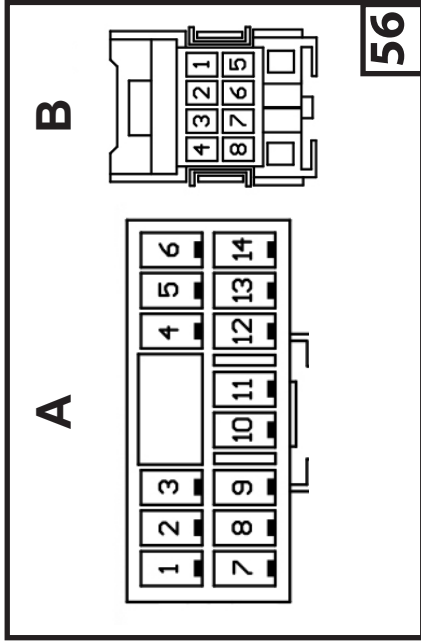
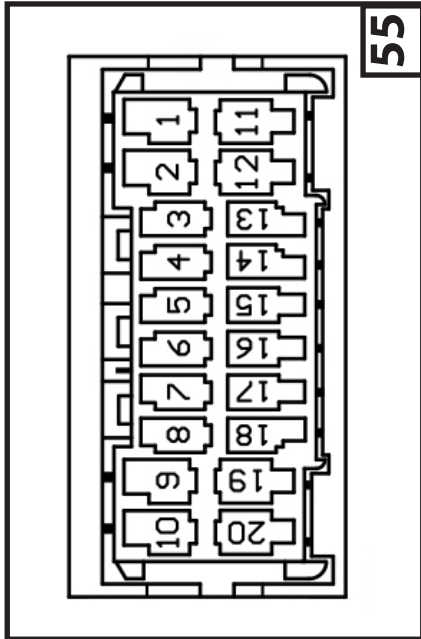
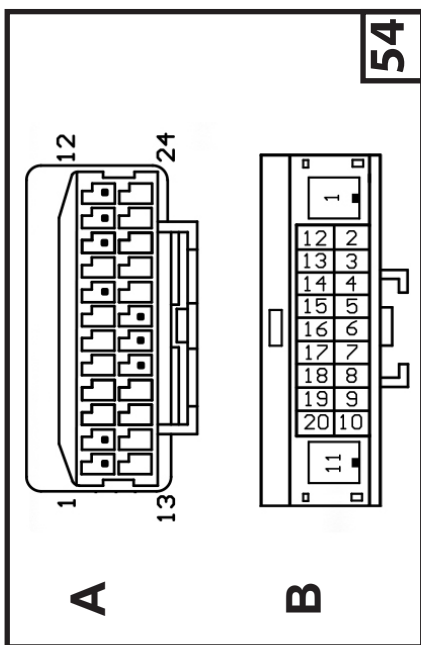

NOTES
