

Note:

Only for BMW without switch panel under climate control unit:

Attach blanking cover to fascia plate (see arrow)



- **BMW 1 (E87) 03/2007-> (facelift)**
- ***with manual air condition***
- ***without iDrive***

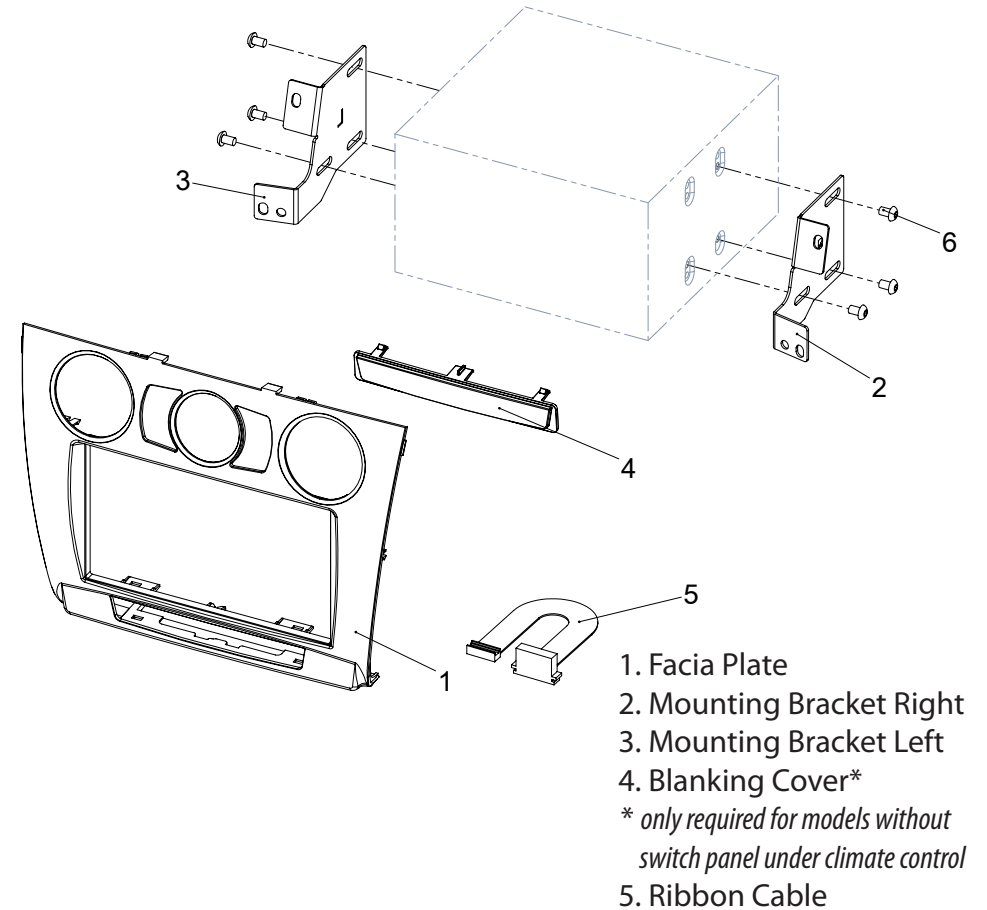

1. Facia Plate
2. Mounting Bracket Right
3. Mounting Bracket Left
4. Blanking Cover*
- * *only required for models without switch panel under climate control*
5. Ribbon Cable



1. BMW 1 (E87) 03/2007 (facelift)
with switch bar under the climate control unit



- BMW without switch panel under climate control unit (see left)
- skip steps 11 - 14
- see note on page 8

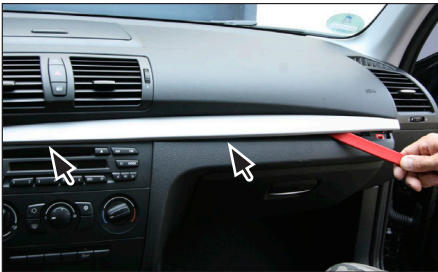

2. Unclip middle panel and remove it carefully



3. Unclip air condition control unit

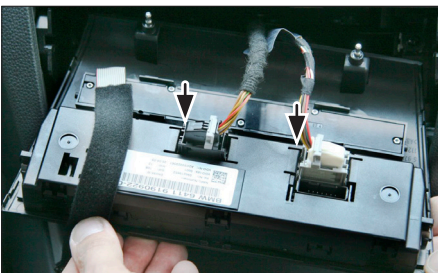

4. Pull out air condition control unit carefully

Remove pulgs (see arrows)

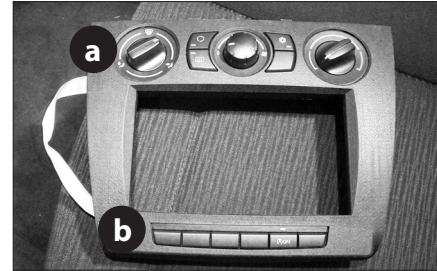

15. Attach air condition control unit (a) and switch bar (b) to replacement facia plate

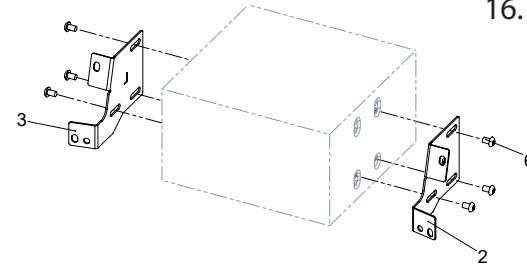

16. Attach mounting brackets to double DIN navigation

Connect all required circuit points

Fix double DIN navigation into dash board



17. Push facia plate over Double DIN navigation - until it snaps in

Reinstall everything in reverse order to finish installation

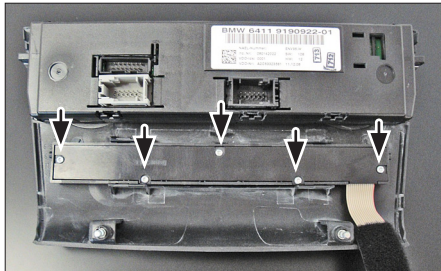

11. Remove 5 screws from switch panel (see arrows)

Take out PCB

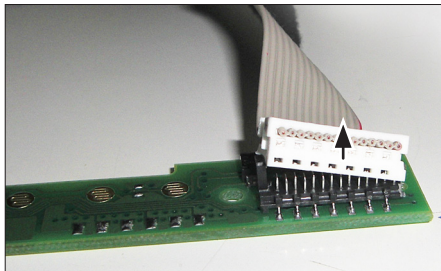

12. Remove plug attached to ribbon cable from PCB

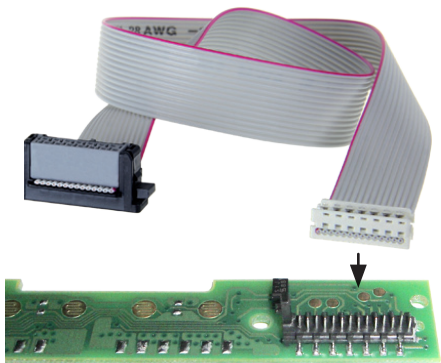

13. Attach white plug of replacement ribbon cable to PCB

Reinstall PCB to switch panel

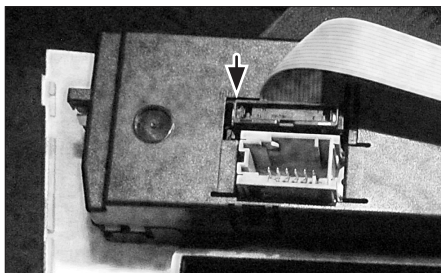

14. Attach black plug of replacement ribbon cable to air condition control unit

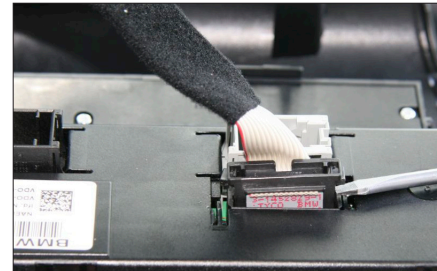

5. Remove plug attached to ribbon cable

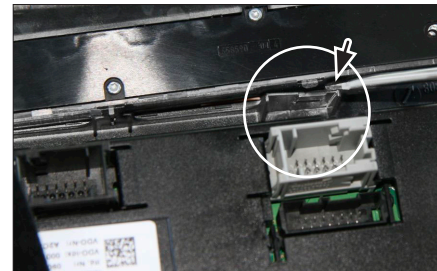

6. Unclip and remove switch panel below air condition control unit



7. Unclip and remove air condition control unit

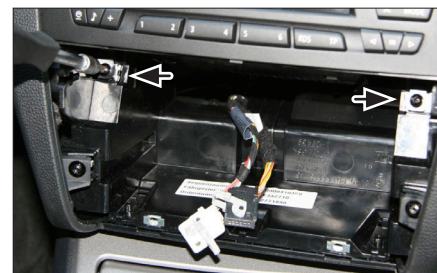
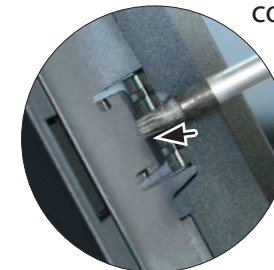

8. Remove screws below OEM head unit (see arrows)

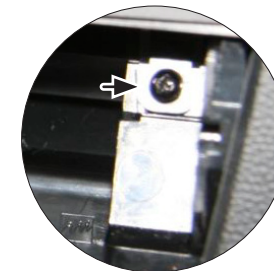

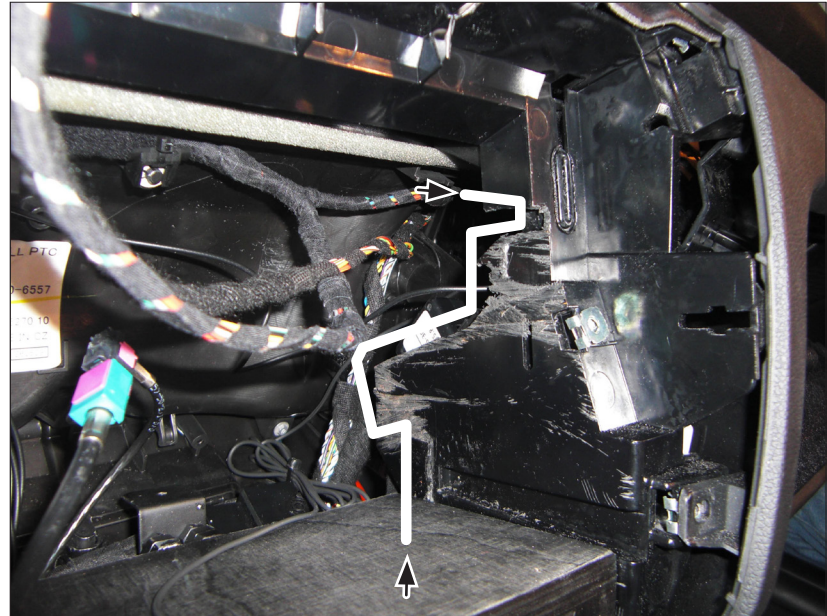
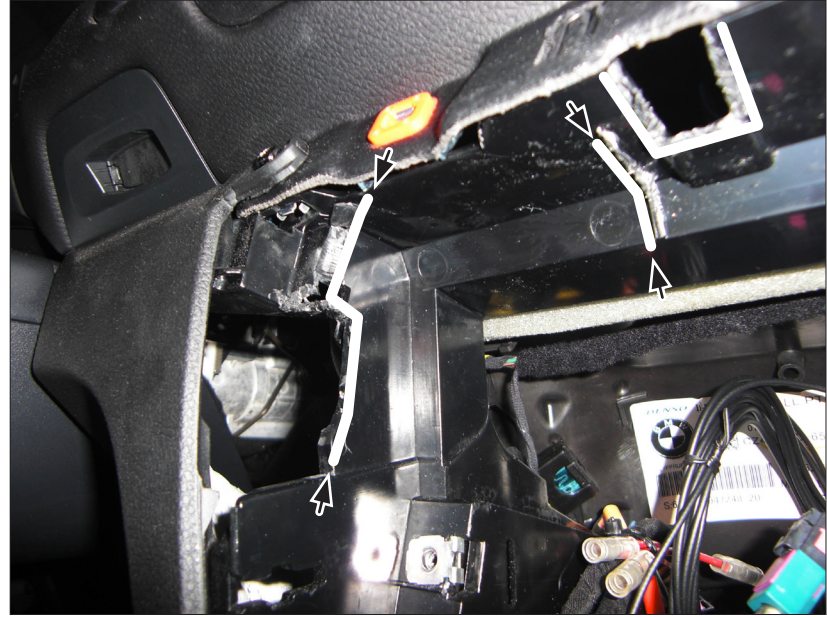

9. Remove out OEM head unit

10. Cut away plastic to clear space for Double DIN head unit (see sample images)