

# ANDROID MULTIMEDIA MONITOR

## USER MANUAL M-AN6560D



**DAB+**  
Digital Audio Broadcasting

# MACROM

# Contents

---

Safety Precautions .....	1-2
Warning.....	2
Product overview .....	3
Setting .....	4
Network and Internet.....	4
Car Infotainment .....	4-8
System .....	9
Radio .....	10
DAB .....	11
Video.....	12
Music.....	13
Bluetooth .....	14-15
Navigation .....	16
Connection view.....	16
Dual screen .....	16
Specifications .....	17
Declaration of Conformity.....	18

## Safety Precautions

---

Thank you for purchasing this product. Please read through these operating instructions so you will know how to operate your model properly. After you've finished reading the instructions, keep this manual in a safe place for future reference.

---

Only connect the unit to a 12-volt power supply with negative grounding.

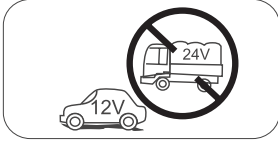

---

Never install this unit where the operation & condition for safe driving is impaired.



---

Never use the video display function in the front when driving to prevent the violation of laws & regulations and also to reduce the risk of traffic accident except for using rear view video camera.



---

Never expose this unit, amplifier, and speakers to moisture or water to prevent electric sparks or fire.

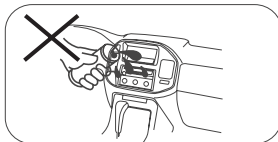

Please don't change the fuse on the power cord without professional guidance, using improper fuse may cause damage to this unit or even cause fire.

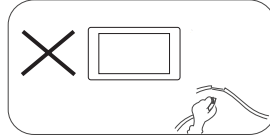

---

Please contact your nearest dealer if one of the following symptoms is experienced:

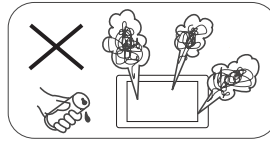

- (a). Water or other objects enters the unit.
- (b). There is smoke.
- (c). Peculiar smell.

---

To ensure safe driving, please adjust the volume to a safe and comfortable level in case of emergency situations.

# Safety Precautions

1. Never disassemble or adjust the unit without any professional guidance. For details, please consult any professional car shop / dealer for inquiry.
2. If the front panel or TFT monitor is dirty, please use a clean silicone cloth and neutral detergent to wipe off the spot. Using a rough cloth and non-neutral detergent such as alcohol for cleaning may result in scratching or decoloration to the monitor.
3. If any abnormal behavior of the unit is found, please refer to trouble shooting guide of this manual. If no relevant information is found, please press the [RESET] key on the front panel to resume factory default.
4. If you have parked the car in hot or cold weather for a long time, please wait until the temperature in the car becomes normal before operating the unit.
5. Using the car heater in low temperature environment may result in moisture inside the unit, DO NOT use the unit in this situation. Eject the disc and wipe off the moisture on the disc. If the unit still doesn't work after a few hours, please contact the service center.
6. Do not impact the LCD monitor which could cause damage.
7. To prevent damage to the screen, avoid touching it with sharp objects.
8. To provide a clear demonstration and an alternative for easy understanding to the operation of this unit, graphic illustrations are used.  
However, some illustrations are different from the actual images displayed on the screen.
9. Operate the unit correctly according to this manual to prevent unnecessary problem. The guarantee won't be valid if the problem is caused by inappropriate operation.

# Warning

## Detect parking brake

- In order to be able to install the android application, the handbrake connection must be connected. Engage the parking brake for APP installation.
- Connect the cable "BRAKE" to the parking brake switch to view video files on the TFT monitor. Engage the parking brake for viewing videos.
- When the parking brake is not engaged, the monitor displays "Warning!!!, Video playback is disabled for your safety. Engage parking brake to watch video.", preventing the driver to watch content while driving. The rear screens are not interested in this inhibition.

Importante note:

This connection is indispensable for the proper operation.

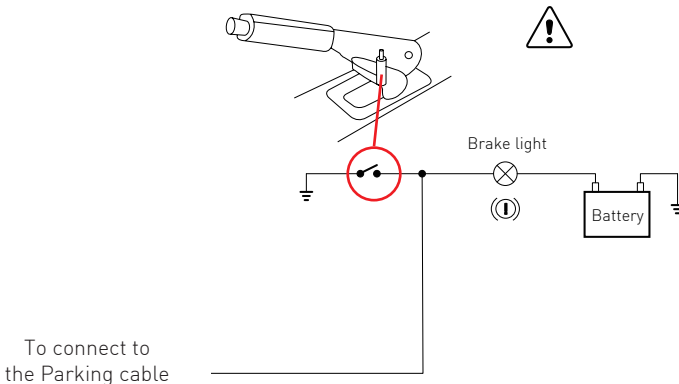

# Product overview

Through the home page you can access the functions of the multimedia unit.

## Power On / Off the unit

When the unit is connected to the vehicle ignition system, press the front panel to turn on the unit. To turn off the unit, remove the car ignition key.

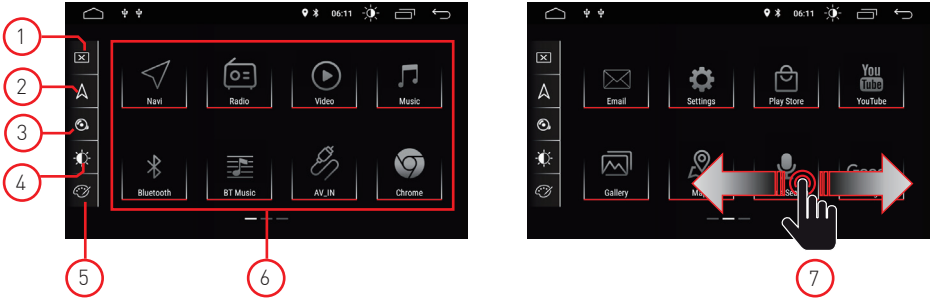

### 1. Screen

Press the icon to turn off the screen. Touch the screen in any position to activate the view.

### 2. Navigation

Press the icon to go directly to the navigation function.

### 3. Audio control

Use the audio icon to adjust the sound system.

### 4. Brightness

Press the icon to access the screen brightness settings.

### 5. Interface colors

Allows access to the color settings of the user interface.

### 6. Source selection

Press the app to view Radio, Music, Video, USB Playback, or AVIN mode and other functions.

### 7. Cursor

Scroll left or right to switch between pages.

## Playback mode and position memory

When the car is restarted, the system resumes the previous mode before switching off.

For the radio, it will resume the radio channel before switching off.

For music or video, it will resume playing the last song or video before turning it off.

# Setting

1. Touch setting icon [  ] on the front panel to enter Settings interface. Select the corresponding option to enter the corresponding settings option. Move the options bar up and down to find the desired settings.

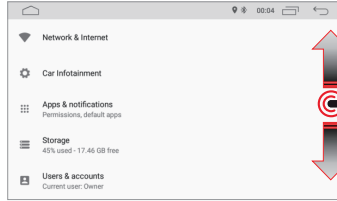
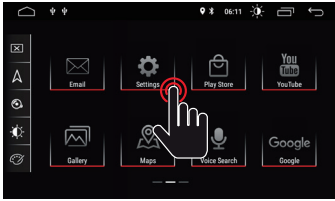

Option bar



Note: some settings require activation via the On-OFF selector.

# Rete e Internet

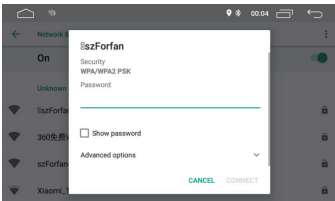

## WI-FI

Select On to achieve the Wi-Fi, then select the desired access points and insert the password.

## Hotspot

Select On to achieve the Wi-Fi hotspot, then select the desired Network name and insert the password.

# Car Infotainment (Common)

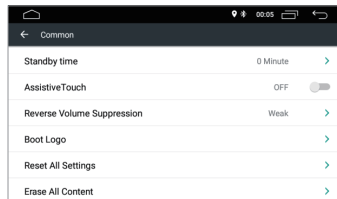
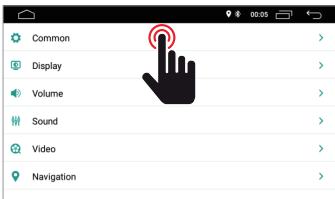

## Standby Time

This function allows to delay the switching off of the device through the selected time.

# Car Infotainment (Common)



## Assistive Touch

User can choose to turn on or off the touch assist. The touch assist has 7 most commonly used options and is displayed on top of the screen at the interface where it provides the user easy maneuver of the unit.



## Reverse Volume Suppression

In order to adjust the volume while you drive in reverse mode, select one of four settings between None, Weak, Medium and Strong. The volume will be reduced according to the selection.

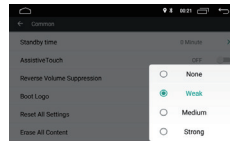

## Boot logo

To select the welcome logo it is necessary to enter the password (5678).

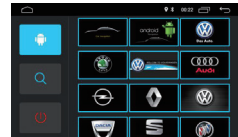

After selected the desired logo press (OK) to confirm the logo update.



## Reset All Setting

In order to restore all factory setting, press the OK button on pop-up dialogue. All your settings will be removed.



## System Restore

By selecting the System restore, all application installed by the user will be removed and the system will restore to the factory settings.

## Car Infotainment (Common)

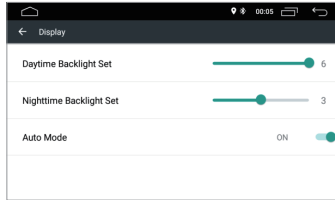
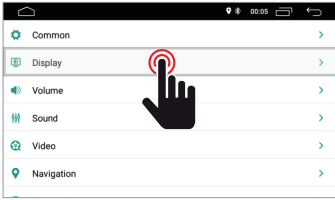

**Daytime Backlight Set**  
Adjusts the brightness of the screen in day mode.



**Nighttime Backlight Set**  
Adjust the brightness of the screen in night mode.



**Auto Mode**  
When the vehicle lights are switched on, it is possible to select automatically the brightness mode of the screen according to the above settings.



**Key Light Color**  
Allows you to select the color of illuminations keys.

## Car Infotainment (Volume)

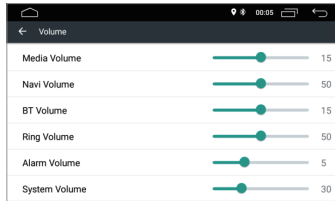
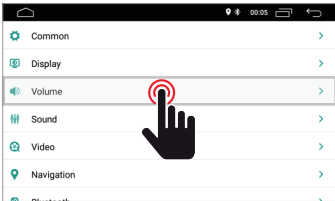

**Volume**  
The volume level can be changed according to the selected source.

## Car Infotainment (Sound)

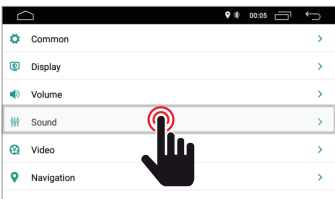

**Sound**  
The sound can be modified through the graphic equalizer and at the moment it is possible to modify the prostrate point by using the four arrows.

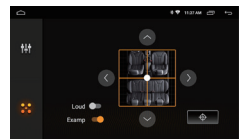



## Car Infotainment (Video)

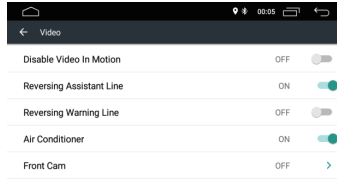
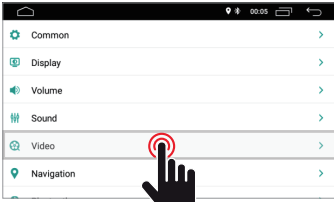

### Disable Video in Motion

Video playback is disabled for your safety. Engage parking brake to watch video or select the switch in ON position.

### Reversing Warning Line

By enabling this option, while driving at reverse position the assistant line will be shown at the display.

### Reversing Assistant Line

NOTE: This feature can only support certain car models.

By enabling this option at reverse position, the assistant line will be shown at the display by moving the steering and aligned in accordance to the steering movement during reverse.

### Air Conditioner

NOTE: This feature can only support certain car models.

By enabling this option, the air condition of the car will be displayed during adjustment.

### Front Cam

Enabling this option, after having disengaged the reverse gear, it will be possible to view the front camera for a time between 3, 5 or 8 seconds.

## Car Infotainment (Navigation)

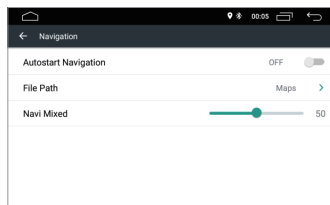
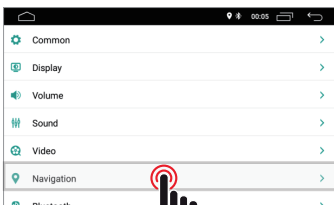

### Autostart Navigation

Allows the user to set the automatic start of the navigation system when the unit is turned on:

### File Path

Allows the user to customize the navigation system according to the installed applications.

### Navi Mixed

Allows the user to mix the audio of the navigation system with the audio of the media sources being played.

# Car Infotainment (Bluetooth)

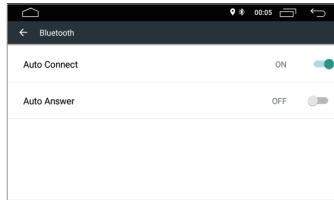
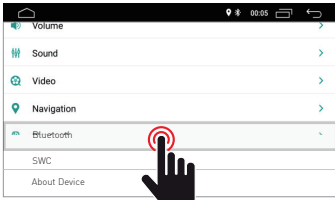

## Pin Code

To connect your Bluetooth device to the unit, you need to pair the device to the unit. Pairing needs only to be done once. Enter default password "0000".



## Auto Connect

By enabling this function, the unit will auto search and auto connect with the last connected device.



## Auto Answer

By enabling this function, the unit will auto answer all incoming calls.

# Car Infotainment (SWC)

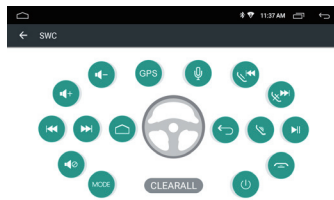
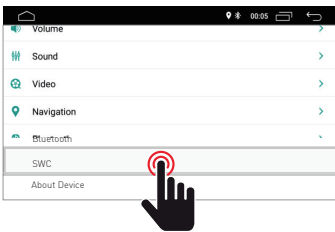

## Steering Wheel Control Programming

Please follow the steps below to set the functions of your steering wheel.

1. Press CLEAR ALL before proceeding
2. Press a button on the steering wheel
3. Touch the corresponding feature of the control button on the touch screen.
4. When the control button turns blue, it means that the setup was successful.
5. Repeat the steps 2 - 4 to complete all control button setting available on your steering wheel.

# Car Infotainment (About Device)

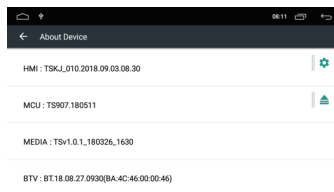
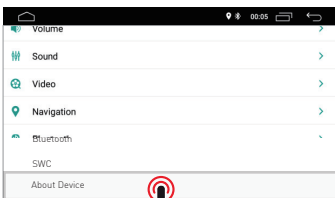

## Version Information

System information.

# System

Touch the System icon to set the language of the user interface and to set the date & time.

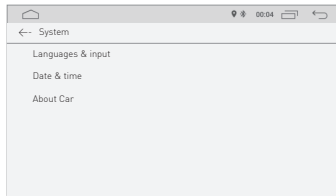
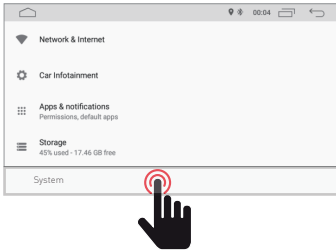

## Languages & input

Allows the user to set the system language.

By "Add a language" it is possible to add the different language from the default.

Scroll the list of available language, select the desired language and press to confirm.

To define the system language, drag the desired language to position 1



## Data & time

Allows the user to set the Datye & time.

Follow the different options provided by the system to obtain the time and date displayed on the product.



## About car

Information on the product is shown

# Radio

Touch the radio icon on the main interface to enter radio mode. You may also touch the radio icon at the application page.

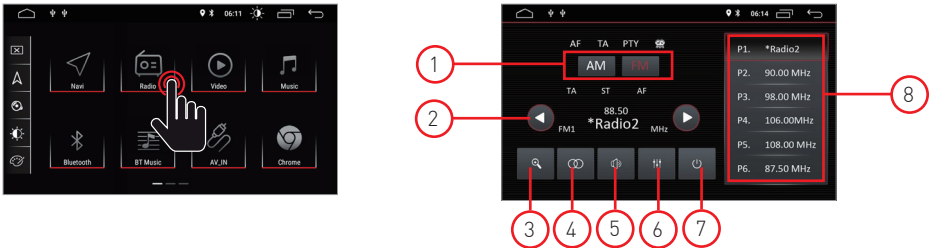

## 1. Band search

Press Band to select FM1, FM2, FM3 and for AM1, AM2

## 2. Search for radio channels

Use the arrow icon (< / >) to search for the next or previous radio station.

When a radio station is found, the search will stop automatically and the unit will sound.

## 3. Automatic search

When you press the search button, the system will automatically search for frequency 88.00 until unit find the radio station with the strongest signal.

To stop the search, tap the icon again.

## 4. Stereo/Mono

Allows you to select the reception mode between Stereo or Mono.

## 5. Volume

Scroll the bars left and right to adjust the volume level.

## 6. Audio settings

Use the icon to adjust the sound of the system.

## 7. Sound settings

When ACC is connected, press the power button on the front panel to turn on the unit. Turn off the unit and disconnect the car key to turn off.

## 8. Preselection of radio channels

Each band can store up to 6 radio channels.

The system can store 24 radio channels (18 FM channels and 6 AM channels).

# DAB

Touch the radio icon on the main interface to enter DAB mode. You may also touch the radio icon at the application page.



## DAB radio overview

### Overview

1. DAB signal level
2. Broadcaster logo  
*(this service may not be provided by the tuned broadcaster)*
3. Information
4. Previous station
5. Next station
6. List of favorite stations
7. General settings
8. List of received stations



### Settings

1. General  
App startup settings
2. Cage  
Graphic personalization of the screen
3. Audio  
Audio settings
4. Stations  
Automatic scan
5. Channel logos  
Issuer logos update
6. Information  
Application info

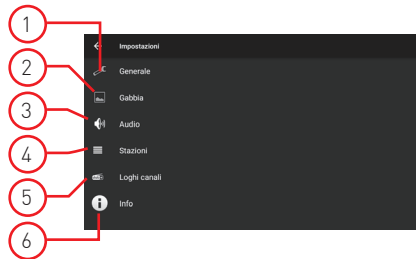

# Video

Touch the music video icon at the main interface. It supports flash internal storage card, music and video stored in USB drive, ape, flac and other formats.

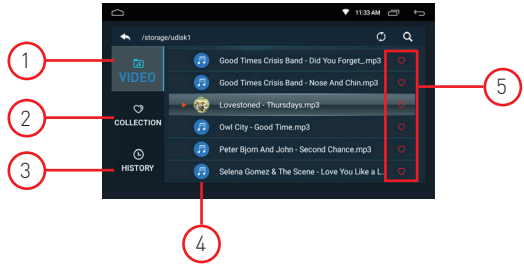
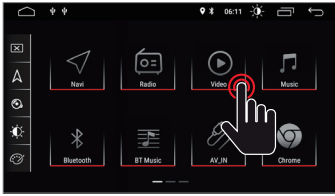

## 1. Video folder

The video folder contains all the folders containing the videos.

## 2. Collection

The collection contains your favorite videos file

In the video list you can select videos that will be directly visible in the list of the collection.

## 3. History

The list shows the video previously played on

## 4. Video files

Press the desired video to start playback

## 5. Favorite

Highlight the icon  to allocate the video in the favorites collection list.

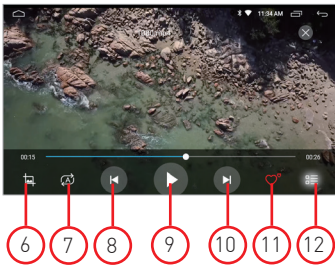

## 6. Screen video format

Best fit - Fit horizontal - Fit vertical - Full screen - 16:9 - 4:3 - Center.

## 7. Repeat file

Press to repeat single or folder playback.

## 8. Previous video

Press to return to the previous video.

## 9. Play & Pause

Press to start playback or to Pause the video.

## 10. Next video

Press to go to the next video.

## 11. Collection favorite

Press to select the favorite videos in the collection list.

## 12. Back to video home

Press to go back to the home page.

# Music

Touch the music icon at the main interface. It supports flash internal storage card, music and audio stored in USB drive. The unit supports MP3 cover display.

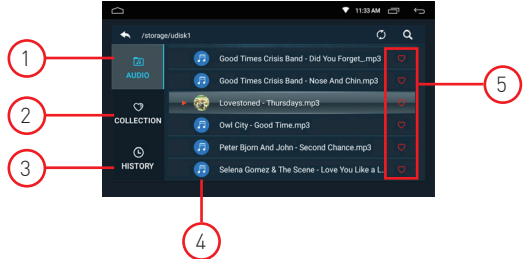
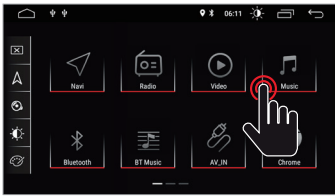

## 1. Audio folder

The audio folder contains all the folders containing the audios.

## 2. Collection

The collection contains your favorite audios file.

In the audio list you can select audios that will be directly visible in the list of the collection.

## 3. History

The list shows the audios previously played on

## 4. Audio files

Press the desired audio to start playback

## 5. Favorite

Highlight the icon  to allocate the audio in the favorites collection list.

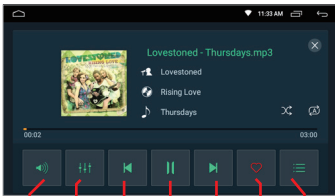

## 6. Volume

Press to adjust the volume.

## 7. Equalizer

Press to adjust the sound of system .

## 8. Previous audio

Press to return to the previous audio track.

## 9. Play & Pause

Press to start playback or to Pause the video.

## 10. Next audio

Press to go to the next audio track.

## 11. Collection favorite

Press to select the favorite audios in the collection list.

## 12. Back to audio home

Press to go back to the home page.

# Bluetooth

Bluetooth's hands-free function enables you to call safely while driving. Touch the Bluetooth icon to enter in the bluetooth setting.

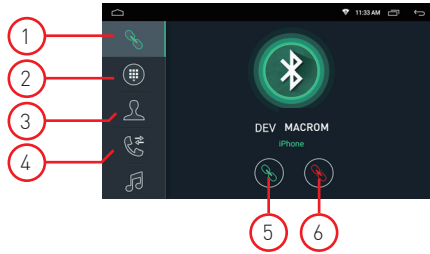
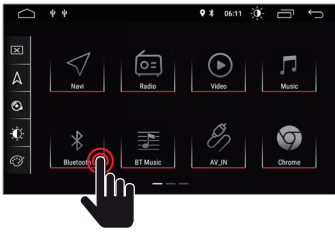

## 1. Pairing

- To activate the bluetooth hands-free function, pair your mobile phone with the unit.
- Turn on bluetooth and bluetooth device search function on your mobile phone.
- Search for the name M-AN6560 of the unit.
- You are required to key in the corresponding PIN number i.e. 0000 on your mobile phone to connect to the unit.
- Once connected, a "CONNECTED" sign will appear on the screen.

## 2. Keyboard

Upon establishing the bluetooth connection, user can dial directly on the phone or key in telephone numbers on the dial pad.

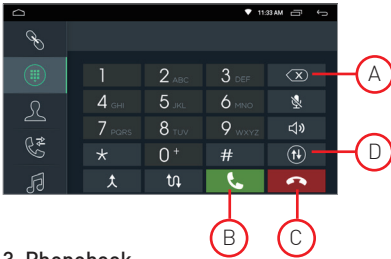

- Touch ( A ) to delete the incorrect number dialed.
- When you dialed telephone number, press ( B ) to call or ( C ) to hang off.
- During conversation, user can touch ( D ) on the screen to switch between private mode and loud speaker.

## 3. Phonebook

The contacts can be download from mobile phone to the unit.

## 4. Call history

Call history shows outgoing call, incoming call and missed call. User can perform call or delete in call history.

## 5. Connection

If the mobile phone has already been paired with the unit, press  to re-connect the device.

## 6. Disconnection

Press  unplug the device.

## 7. Phonebook synchronization

The contacts can be download from mobile phone to the unit.

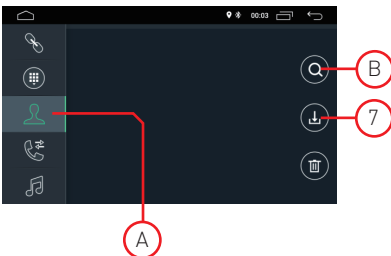

- Once bluetooth is connected, touch  to download the contacts.
- Once download is completed, name of the contact will be shown on the display screen during phone call. Press ( A ) to view the contact list.
- For quick access to the contacts, use the name search begins with first alphabet ( B ).



# Bluetooth

---

## 1. Call history

Call history shows outgoing call, incoming call and missed call. User can perform call or delete in call history.

## 2. Bluetooth Music

This unit supports bluetooth music playing.

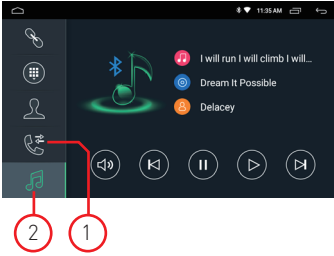

User can play music on the mobile phone and transfer it to the loud speaker of the car via bluetooth. It also supports simplified controls such as "Previous", "Next", "Pause" and "Play".

NOTE: Due to bluetooth compatibility, the unit may not support all features or all phone models.

# Navigation

---

## GPS Satellite Navigation Operation

The invention of GPS navigation has brought to the convenience of travelling today. By using the GPS positioning and electronic navigation map, user can reach the destination faster and more efficiently. To navigate accurately, both the GPS positioning and navigation map are equally important. The GPS provides precise positioning and fast calculating speed while the navigation map provides huge information, data and route planning.

## Navigation Map Data

The data of some navigation applications can be stored externally in SD card or USB drive.

Note:

Some navigation application defaulted its route planning on the map and may not support storage in external SD Card and USB Drive.

## Installation of APK Navigation Application

Before navigation, please install APK Navigation Application and ensure the APK navigation map is correctly installed.

## Navigation Activation

Upon successful installation of APK Navigation Application, there will be a corresponding icon on the homepage. Touch the icon to launch the application.

User can also go to "Car Infotainment" → "Navigation" → "File Path " to link the navigation button and application. Upon linkage, user may press the "Navigation Button" to start the navigation directly.

## Navigation Application Operation

Please refer to the corresponding operation manual for details in navigation application.

# Dual screen

## Dual screen function

Some applications are supported by the dual screen function. It is therefore possible to divide the screen in half and display two applications simultaneously.

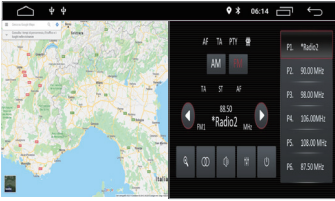

Press  to view the open applications and then select the desired applications to be displayed on the screen simultaneously.

Note: some applications may not be supported by screen sharing.

# Connection view

Diagram of M-AN6560

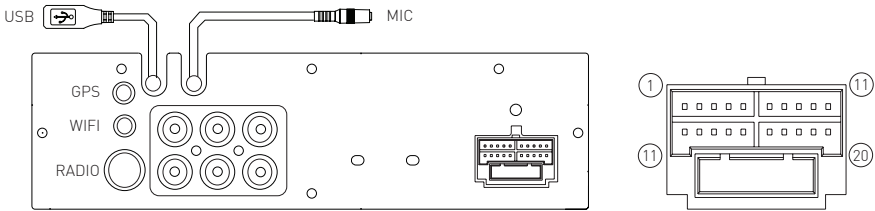

### RCA CONNECTION

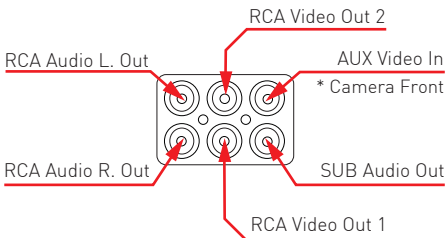

### POWER CABLE CONNECTION

1 Front Left +	1 Rear Left +
2 Front Left -	2 Rear Left -
3 Front Right +	3 Rear Right +
4 Front Right -	4 Rear Right -
5 Brake (Parking)	5 Battery + (Yellow)
6 Illumination	6 GND (Black)
7 NC	7 ACC Power (Red)
8 SWC KEY 1	8 Antenna Power
9 Reverse	9 SWC KEY 2
10 Camera Video In	10 NC

\* The Aux In input, if necessary become an input for the front camera video. Through the settings found in the CAR INFOTAINMENT in the VIDEO → FRON CAM section it is possible to activate the auxiliary input for viewing the front video camera. See page 7

# Specifications

---

## General

Reference Supply Voltage .....	12V ==
Operating Voltage Range .....	9 - 16V ==
Max Operating Current.....	15A
Grounding System Car Battery Negative Pole	

## FM

Signal Noise Ratio .....	≥55dB
Residual Noise Sensitivity (S/N=30dB) .....	≤10dBμV
Frequency Response (±3dB) .....	40Hz~12KHz
Station Seeking Level.....	23±3dBμV
Distortion .....	≤1.0%
Stereo Separation (1KHz).....	≥25dB
Antenna Impedance.....	75Ω
Frequency range.....	87,5 /108,0MHz

## AM

Residual Noise Sensitivity (S/N=20dB) .....	≤28dBμV
Selectivity (±9KHz) .....	≥50dB
Frequency range.....	522/1620KHz

## DAB

Residual Noise Sensitivity (RF=72dBm).....	60dB
Stereo Separation (1KHz).....	≥55dB
Frequency range.....	174 /240MHz

## BT

Frequency .....	2,402 - 2,480GHz
-----------------	------------------

## Power output

Frequency Response (±3dB) .....	50Hz~16KHz
Maximum Output Power .....	4×45W
Load Impedance .....	4Ω

## AUX IN

Distortion .....	≤0.5%
Frequency Response (±3dB) .....	50Hz~20KHz
Audio Input Level .....	0.5Vrms

## Audio

Audio Output Impedance .....	100Ω
Audio Output Level .....	2Vrms(Max)

## Video

Normal Video Input Level (CVBS) .....	1.0±0.2V
Video Input Impedance .....	75Ω

## Environment

Operating Temperature.....	-20°C ~ +70°C
Storing Temperature.....	-30°C ~ +80°C
Operating Humidity.....	45%~80%RH
Storing Humidity.....	30%~90%RH

# Declaration of Conformity

---



The manufacturer GMA ITALIA s.r.l. declares that the type of radio equipment - Multimedia Monitor, model M-AN6560D, brand Macrom - complies with the 2014/53 / EU Directive.

The full text of the EU Declaration of conformity is available at the following internet address: [www.macrom.it](http://www.macrom.it), or at GMA ITALIA s.r.l. - V. Di Vittorio, 7/33 Rho - 20017 (MI) Italy

Made in China by  
GMA ITALIA s.r.l. - Via G. Di Vittorio, 7/33 Rho - 20017 (MI) Italy

## Information on disposal of unit

---



This product bears the selective sorting symbol for waste electrical and electronic equipment (WEEE).

This means that this product must be handled to the local collecting points or given back to retailer when you buy a new product, in a ratio of one to one (or one to zero if the external dimension is less than 25 cm) pursuant to European Directive 2012/19/EC in order to be recycled or dismantled to minimize its impact on the environment.

For further information, please contact your local or regional authorities.

Electronic products not included in the selective sorting process are potentially dangerous for the environment and human health due to the presence of hazardous substances.

The unlawful disposal of the product carries a fine according to the legislation currently in force.

